

**British Amateur
Tape Recording
Contest Results**

TAPE

**RECORDING
FORTNIGHTLY**

EVERYONE'S GOING ELIZABETHAN!

ELIZABETHAN CUT TAPE RECORDING COSTS IN HALF!

Double the playing time, double the versatility. That's what you get when you switch to Elizabethan 4-track. Yet an Elizabethan 4-track tape recorder costs no more than most ordinary twin-track machines!

DOUBLE-UP ON YOUR EXISTING TAPES

Not only can you play your present twin-track tapes on an Elizabethan 4-track machine—you can actually *add two more tracks!* Thus you can literally double your own collection of recordings without buying a single foot of new tape!



GOING FOR-ELIZABETHAN 4 TRACK!

FT1

4-Track at its most economical. Over six hours' recording time. Press-button track selection. Independent mixing and bass/treble controls. And easy adaptation for stereo playback (with add-on unit).

ONLY 39 GNS
complete

FT3

Up to seventeen hours on one tape! With press-button selection for any of the four tracks. Three speeds. Independent mixing and bass/treble controls. Easily converted (with add-on unit) for complete stereo recording and playback.

ONLY 55 GNS
complete

GOING FOR PROFESSIONAL STANDARDS

MAJOR

Performance standards only found previously in highest grade professional equipment. Twin-track 3 micron gap head giving 50-20,000 c/s response. Three speeds. Six watt push-pull output. Meter level indicator.

ONLY 65 GNS
Mic. optional extra

ELIZABETHAN (TAPE RECORDERS) LTD., ROMFORD, ESSEX. TELEPHONE: ROMFORD 62366/7

FIRST AND FOREMOST IN THIS FIELD

FORTNIGHTLY 1/6
7th September, 1960

BRITISH AMATEUR TAPE RECORDING CONTEST

**Three
1st Prize winners
used **Emitape****

1st Prize Compositions Section

(Emitape Silver Challenge Cup for the Tape of the Year)

N. Paul, Esq., Muswell Hill. The Rest is Silence

1st Prize Clubs Section

C. J. Garrett, Esq., Tonbridge

Ban the Phon

1st Prize Schools Section

P. J. Kingston Esq.

Peterborough V.C. Primary School

Our School

Emitape—the tape used for the ‘masters’ of most records

made by



Emitape Division
EMI Sales & Service Ltd
Hayes, Middlesex

EMI

Who reads Ferrograph Advertising?



Some have bought their Tape Recorders because they liked the look of them. Others because their price was attractively low. Still more because they didn't know much about Tape Recorders anyway and sought the advice of their friends. All these are good and valid reasons and, we hasten to add, most will probably be quite satisfied with their purchases. But the purchase of a Ferrograph falls into rather a different category. Being almost always in short supply—inevitable with a high precision instrument requiring so much individual supervision during manufacture—only a relatively small number of Dealers can be permitted to distribute it. Our advertising, therefore, seeks to overcome this handicap by appealing to those thoughtful and discerning people who are more influenced by reputation and performance than by any other consideration. That is why there are no sensational claims or grandiose statements in Ferrograph advertising. It is sober, restrained and free from exaggeration. We believe that the purchase of a Ferrograph is a serious business—that almost invariably it is bought by those who, like the B.B.C. and other broadcasting organisations and leading personalities in the world of music and drama, are capable of assessing its great qualities at their true worth.

Stereo 808

Two speeds $3\frac{3}{4}$ i.p.s. For use with external Hi Fi amplifiers and Loud Speakers. The all-purpose machine for Monaural and Stereo Recording/Playback.
105 Gns.

Series 4A

4A/N Two speeds $3\frac{3}{4}$ i.p.s. Monaural Recording/Playback.
81 Gns.

Three Independent Motors • Synchronous Capstan Motor • Recording Level Meter • Brief Stop • Interchangeable Plug-in-Heads
Switched Speed Change with Compensated Correction Network • Separate Tone Controls • High Fidelity $2\frac{1}{2}$ Watts Output Stage
Uses $8\frac{1}{2}$ " Tape Spools • Gear-Driven Turns Counter • Automatic Switch Cuts Motors at End of Spool • Endless Loop Cassette (Optional Extra)

The Incomparable **Ferrograph**

BRITISH FERROGRAPH RECORDER CO. LTD.

(A subsidiary of the Ferrograph Company Ltd.)

131 SLOANE STREET, LONDON, S.W.1 • Tel: SLOane 1510, 2214 and 2215

HI-FI AT

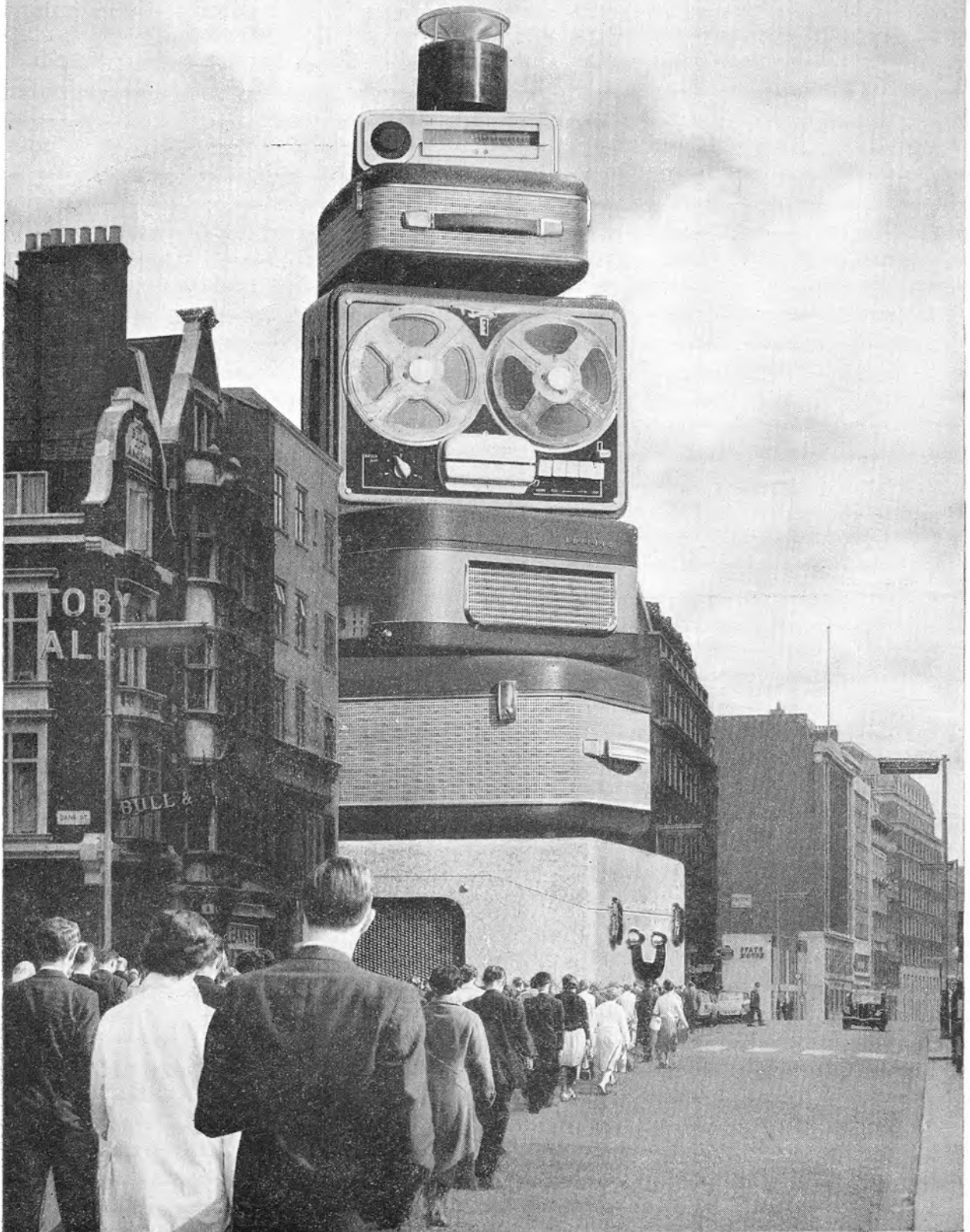

HI-HOLBORN

Here is important news for everyone interested in Tape Recording and Hi-Fi: The Tape Recorder Centre—for years the country's leading specialists—have opened a unique, extensive **NEW SHOWROOM IN THE HEART OF THE WEST END**

easy to get to, easy to buy from, just one minute from Holborn Station.

Sensational Stocks: All makes of Tape Recorders and Hi-Fi Equipment on view all the time. All the latest from the Radio Show—easy to get to, easy to choose. Hundreds of models and types in one and the same place, for your personal inspection.

Sensational Terms: In the new Showroom, too, the unbeatable Tape Recorder Centre credit terms: NO INTEREST CHARGES and minimum deposits, up to 18 months to pay, on orders over £30; or the exclusive Tape Recorder Centre Low-Interest Two-Year plan.

Sensational Demonstration Facilities: Demonstrations and advice from enthusiastic Tape Recorder Centre experts. Ideal conditions for you to compare different models on the spot—take your time—make sure you buy right.

* CHOOSE IN PERSON

at the new Central London Showroom:

82 HIGH HOLBORN · LONDON WC1

Telephone: CHAncery 7401

or at the North London Showroom: 75 Grand Parade, Green Lanes, Harringay, London, N.4 Tel: STAmford Hill 1146

THE TAPE RECORDER CENTRE

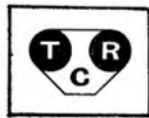

Tape Recorders

GRUNDIG
ELIZABETHAN
FERROGRAPH
VORTEXION
WALTER
BRENELL
REFLECTOGRAPH
SIMON
HARTING
TELEFUNKEN
PHILIPS
SPECTONE
H.M.V.
VERITONE
STUZZI-MAGNETTE
FI-CORD
TRUVOX
KURLAND
REPS
WYNDSOR
REGENTONE
PERTH-SAJA
ELEKTRON
MINIVOX
KORTING
Hi-Fi Equipment
Microphones,
Speakers, etc.
LEAK
QUAD
ROGERS
ARMSTRONG
JASON
DULCI
PAMPHONIC
STENTORIAN
AVANTIC

S.M.E.

COLLARO
GOODSELL
ELPICO
DECCA
PHILIPS
WRIGHT & WEAIRE
G.E.C.
GOODMANS
C.Q.
WHARFEDALE
ELAC
B.J.
GARRARD
CONNOISSEUR
GOLDRING
T.S.L.
ACOS
LUSTRAPHONE
CADENZA
RESLO
RECORD HOUSING
LINEAR
TANNOY
ORTOFON
AURIOL
LOWTHER
FILM INDUSTRIES
AUDIOMASTER
Tape
EMITAPE
SCOTCH BOY
BASF
GRUNDIG
TELEFUNKEN
IRISH
PHILIPS
AGFA

All Accessories, Tapes, etc. by return of post. All makes in stock.

FREE 72-PAGE CATALOGUE LISTING HUNDREDS OF MODELS

* CHOOSE BY POST—from FREE 72-page Catalogue

If you cannot visit either of the two Showrooms, send this coupon today for a FREE copy of the unique Tape Recorder Centre catalogue—72 illustrated pages, giving you full details of hundreds of Tape Recorders, Hi-Fi Equipments, Loudspeakers, Amplifiers, Accessories, etc., The Tape Recorder Centre Ltd., 75 Grand Parade, London, N.4.

NAME..... ADDRESS

BLOCK LETTERS PLEASE

Get it TAPED – to perfection

– naturally



SIZES	STANDARD			LONG PLAY		
	FEET	TOTAL RUNNING TIME (11 P.S.)	PRICE £ S D	FEET	TOTAL RUNNING TIME (11 P.S.)	PRICE £ S D
3"	150	8 MINS	5 6	225	12 MINS	8 6
4"	300	16 "	10 0	450	25 "	14 6
5"	600	32 "	1 0 0	850	45½ "	1 8 0
5½"	850	45½ "	1 7 6	1200	1 HR 4 MINS	1 15 0
7"	1200	1 HR 4 MINS	1 15 0	1800	1..36 "	2 10 0
8½"	1750	1..33 "	2 10 0	2400	2.. 8 "	3 10 0
DOUBLE PLAY			SUPERGRADE			
3"	300	16 MINS	10 6			
5"	1200	1 HR 4 "	2 5 0			
5½"	1800	1..36 "	3 10 0			
7"	2400	2.. 8 "	4 0 0	1200	1 HR 4 MINS	2 18 6

on

MEMBER OF THE B.I.C.C. GROUP

Mss Mastertape

MSS RECORDING COMPANY LIMITED COLNBROOK, BUCKS TEL. COLNBROOK 2431



LUSTRAPHONE MICROPHONES

with their infinite versatility has enabled competitors in

The NATIONAL TAPE RECORDING CONTEST

to win

THREE out of SEVEN FIRST PRIZES

• • • • •

British-in design-materials and manufacture, is your guarantee of high quality and fidelity reproduction

Full descriptive literature available at

LUSTRAPHONE LTD.

ST. GEORGE'S WORKS, REGENT'S PARK ROAD, LONDON, N.W.1
Telephone: PRImrose 8844

designers and manufacturers of

MICROPHONES FOR ALL REQUIREMENTS

STANDS : TRANSFORMERS : ACCESSORIES

TRANSISTORISED MICROPHONE MIXERS, PREAMPLIFIERS, AUDIO AMPLIFIERS, ETC.

GREAT NEW PERTH CLARISSA MK III



Beautifully styled slim blue and gold case with brilliant gilt fittings and white grille. Speeds— $7\frac{1}{2}$ — $3\frac{3}{4}$ ips. Using $5\frac{3}{4}$ " reels it can take up to three hours recording and play back at $3\frac{3}{4}$ ips. with double play tape. Accidental erasure impossible. Frequency range up to 9kc.s. Monitor through magic eye and built-in speaker. Superimposing and automatic muting of built-in speaker. High gain amplifier circuit. Wide range tone control with large elliptical high flux speaker ensures a clear 3 watts output of outstanding fidelity. Size $15\frac{3}{4}$ " \times $12\frac{3}{4}$ " \times $6\frac{1}{4}$ ". Weight 17 lbs.

$29\frac{1}{2}$ gns

Complete with specially matched crystal microphone and tape

RADIO SHOW STAND 205

PERTH RADIOS LTD., 39-47 EAST ROAD, LONDON, N.1. CLErkenwell 2413-4

DON'T CROSS THE CHANNELS

Stereo tape recording has come to stay. If you want first-rate stereo sound in the end, you must have a first-rate stereo microphone from the start. This microphone must have the same balanced, wide-frequency response as a mono mike, and in addition achieve separation of all sound into two separate channels. Acos microphones have long been amongst the best in the world; Acos are the leading pioneers in stereo. No wonder, therefore, that the new ACOStereo microphone is strictly in the champion class for performance, separation, good looks and good value.



MIC 44

The new ACOStereo MIC 44 is a fully stereophonic microphone, operating on the coincident phase principle. It contains two inserts with figure-eight characteristics, at 90° to each other, giving overall clover-leaf response with first-rate channel separation. Output -68 dB ref 1 V/dyne/cm²; frequency response 50-8,000 c/s; separation better than 12 dB at 1 kc/s. UK retail price £6.6.0.



GET SET FOR STEREO WITH AN ACOSTEREO MICROPHONE

acos ARE DOING THINGS IN STYL! *also*

COSMOCORD LTD WALTHAM CROSS HERTS · TEL: WALTHAM CROSS 25206 (London subscribers please dial WS25206)

Sensational success of audiotape

TRADE MARK

Tape Recording experts and enthusiasts all over the country are changing to AUDIOTAPE for its flawless perfection of sound reproduction over the entire audio range and its *consistent, uniform quality* from reel to reel.

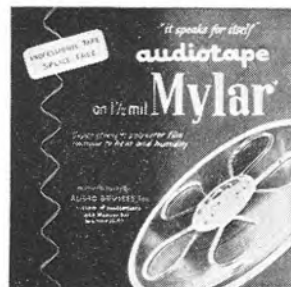

Available on all standard reel sizes, there are eight different types to meet every recording requirement. AUDIOTAPE, manufactured in the U.S.A., by Audio Devices Inc., gives you the truest sound your recording equipment can produce—try AUDIOTAPE . . . it speaks for itself.



Sensational C-SLOT REEL!

All 5" and 7" reels of AUDIOTAPE are supplied on the exclusive C-Slot Reel—the fastest-threading tape reel ever developed. The tape end, dropped into a slot in the hub, anchors itself automatically at the first turn of the reel.



ELPICO A NAME FOR BETTER PERFORMANCE

Concessionaires to the United Kingdom and Eire

LEE PRODUCTS (Gt. Britain) LIMITED

ELPICO HOUSE, LONGFORD STREET, LONDON, N.W.1

Telephone: EUSton 5754 (all lines) Telegrams: Leprod, London.

2 FREE BOOKLETS!

"How To Make BETTER Tape Recordings" (Irish Tape) and
Our SENSATIONAL CATALOGUE with Details of 140 DIFFERENT MODELS!

! R.B. TAPES DO IT AGAIN!

Brand-new FAMOUS FOREIGN TAPE RECORDERS
offered at the Fantastic Price of **35 GNS** Dep. £7.5.0
including TAPE, MIC, AUTO- Bal. 24 mths.
MATIC TAPE STOP, FULL MIXING, FREQU. 50—
16,000 cps. 2½ watts undisturbed output!

LOOK! EASIEST TERMS EVER!

CASIAN Travler	29 gns.	dep. £6 9 0
FANFARE 60	23 gns.	dep. £5 3 0
GRUNDIG TK 24	62 gns.	dep. £13 2 0
ELIZABETHAN Major	65 gns.	dep. £13 15 0
WYNDSOR Victor	45 gns.	dep. £9 15 0

FREE AFTER-SALES SERVICE WITH
12-24 MONTHS GUARANTEE



OPEN ALL
SATURDAY

Agents for:
GRUNDIG
TELEFUNKEN
WYNDSOR
SIMON
VERITONE
SABA
ELIZABETHAN
SOUND
SPECTONE
and many others

R.B. TAPES

THE SIGHT AND SOUND CENTRE

Write NOW For ALL Your FREE
Books!

NAME

ADDRESS

TRM

179 STOKE NEWINGTON HIGH ST

LONDON N16 CLISSOLD 9477

also at 89-91 Gt. Ancoats St. Manchester 4



TWO YEAR GUARANTEE NOT MASS PRODUCED — MADE FOR RELIABILITY AND CONSISTENTLY HIGH STANDARD OF PERFORMANCE

★ 1½ ips can be fitted for an extra 3 gns. ★ Superimposing fitted as standard
★ Provision for 2-or 4-track stereo. ★ Mixing facilities

MODELS:

R20 62 GNS. with magic
eye recorder indicator.

R30 66 GNS. with meter
record level indicator.

R40 70 GNS. as R30 but
with push/pull sound.

TECHNICAL SPECIFICATION

The R40. 1½ ips 70—4,500 ± 3dBs. 3½ ips 60—9,000 ± 3dBs. 7½ ips 50—15,000 ± 3dBs. 15 ips 40—20,000 ± 3dBs. (signal noise ratio at 7½ ips—47dBs.). Separate record amplifier. Push-pull bias erase oscillator for low tape hiss. Separate bass and treble controls ± 15dBs at 14 kc/s—15dBs at 40 c/s. Supplied complete with Acos 39/1 microphone. Radio Record lead and 1,200' PVC Tape.

FURTHER FACTS:

It is not generally known that the Tape Deck mechanism is virtually re-built in the REPS machines. It is standard procedure to remove all rubber wheels—i.e., re-wind, idle and pinch—and re-grind them to a closer tolerance. Also the Capstan is skimmed to less than ± 0.0001". This has resulted in a very low "wow" factor, especially at 3½ ips which has lead to the logical introduction of 1½ ips in place of the 15 ips. The principal cause of "flutter" is due to the eccentricity of the three-step pulleys which control the tape speed. This eccentricity occurs when the pulley is locked to the motor shaft and is due to the off-setting action of the fixing screws. This difficulty has been overcome by manufacturing pulleys over-size and machining to the correct diameter when fitted to the motor shaft. By this method a total variation of less than 0.0001" has been achieved at 1½ ips. Initial measurement indicate total "flutter" content at 1½ ips to be of a lower order than previously associated with 3½ ips.

D. W. Aldous of 'GRAMOPHONE RECORD REVIEW' writes in March issue:—

"The overall performance of this Repls R30 recorder, coupled with its reliability and simplicity of operation, not to mention an attractive styling, must give it a wide appeal to tape recordists seeking an all-British machine of unusual quality."

Please send me without obligation full details of your
range of Tape Recorders. I am particularly interested in

Model R.....

Mr.

REPS (TAPE RECORDERS) LTD.,
Dept. T.R.H. . . . 118 PARK ROAD NORTH
SOUTH ACTON, W.3. . . Telephone: Acorn 4141

TAPE

RECORDING
AND HI-FI MAGAZINE

Vol. 4 No. 18 7th September, 1960

Tape Recording and Hi-Fi Magazine is published fortnightly, on alternate Wednesdays, by Print and Press Services Ltd., from 7 Tudor Street, London, E.C.4

EDITOR: **R. D. BROWN**

TECHNICAL ADVISORY EDITOR: **CHARLES LANGTON**,
A.M.Brit.I.R.E., A.M.Inst.E.

MUSIC: **EDWARD GREENFIELD**
The Guardian recorded music critic

DON WEDGE
News Editor, New Musical Express

MOVIE-MAKING: **JOHN ALDRED**

NEWS AND CLUB ACTIVITIES: **FRED CHANDLER**

OVERSEAS CORRESPONDENTS:

FRANCE: **GEORGES GINIAUX**
Revue du Son, 40, rue de Seine, Paris-6e

U.S.A.: **PETER M. BARDACH**
210-16, Grand Central Parkway, Queens Village 27, New York

The Editor is always glad to receive articles news items, illustrations, etc., intended for publication and payment is made on the first of the month following publication. When not accepted, material will be returned if a stamped addressed envelope is enclosed, but the Editor cannot accept responsibility for the safety of such material.

"Tape Recording and Hi-Fi Magazine" is available by a postal subscription at 45s. per annum, post free, or it can be obtained at newsagents, bookstalls and radio and music dealers. In the event of difficulty, write to the distributors, Rolls House Publishing Co. Brems Buildings, London, E.C.4.

Back numbers, if still in print, are available at 2s. 6d. per copy for issues up to November, 1959, and 2s. per copy for later numbers.

EDITORIAL

Address all communications

7 TUDOR STREET, LONDON, E.C.4
FLE 1455-6

ADVERTISING

All advertising communications to

1 CRANE COURT,
FLEET STREET, LONDON, E.C.4

FLE 0197

IN THIS ISSUE

We take the view . . . 12

The World of Tape 13

A News Digest

THE RADIO SHOW 14

British Amateur Tape Recording Contest 17

Results and Report

B.B.C. Recording Techniques 22

Alec Nisbett

A slight case of murder 25

Dorothy Nixon

Stereo Notes 26

Douglas Gardner

Equipment under Test 27

Stuzzi Magnette

Sound Effects 29

Alan Edward Beeby

Equipment under Test 33

Chitnis KM33

New Products 37

News from the Clubs 39

We take the view . . .

A DIGEST OF NEWS, COMMENT AND EDITORIAL OPINION

WE hear so much about the lack of after-sales service concerning a number of manufacturers, that when the following breath of fresh air arrived in the office, we thought it should be recorded.

The Secretary of a small tape recording club found that the club's newly-purchased Telefunken recorder had developed a fault after only a week's use. He immediately contacted Welmec Ltd., who just as promptly arranged for an engineer to attend in a few days so that the club should be inconvenienced as little as possible. Furthermore they carried out their promise.

Such excellent service, although a customer's due, makes an impression on members thinking of buying new equipment.

What a pity that this little story should be so rare as to warrant publication.

New voices

THERE really seems to be no end to the wonders possible in the world of audio. A Rickmansworth dental surgeon has now devised a midget apparatus which will provide a "voice" for people who have lost the use of their vocal chords.

It fits into the mouth like a denture, has a vibrating metal diaphragm about the size of a sixpence, and is powered—at present—by a battery which has to be carried separately. The inventor is working on an improved version which may be carried entirely in the mouth.

The metal diaphragm is made to vibrate by the person forming the words with his mouth and the words come out clearly, but in a monotone.

Stereo/mono discs

FROM America comes a story of a mono/stereo disc which is likely to be marketed over here before long and which should be the subject of much interested controversy. They are claimed to be entirely compatible—we are promised that they can be played monophonically until we have equipped ourselves with

a second channel, and stereophonically afterwards.

The system has been developed by a British engineer, John Molesey, and the discs have been selling briskly in the United States.

Propaganda

THE current publicity campaign by Grundig is probably the biggest thing of its kind in the tape recording field that we have seen in this country. I like particularly the booklet featuring top show business stars which the firm has been sending free to inquirers.

A dozen stars wittily and sensibly put across the attractions of tape recording. It is splendid propaganda not only for Grundig, but for the industry as a whole.

What next!

IT is fairly general knowledge that many of the larger air

corporations provide music for passengers on the flights, and in our last issue we reported the installation of a stereo sound system on board ship.

There does not seem to be any room for improvisation along the lines of comfort now that "in the air" and "on the water" have been covered.

At least, that is what we thought until we heard that in Sussex, guests at a hotel can now be entertained while swimming UNDERWATER.

The hotel is Ye Olde Fellbridge at East Grinstead, where Magneta (B.V.C.) Ltd., have recently installed special loudspeakers in the newly completed solar heated Bahamas Pool.

Linked to a general sound system for background music on the Reditune principle, the layout incorporates a 50 watt amplifier serving twenty-four speakers. These are operated on eight circuits distributing sound throughout the hotel and its surrounds.

The speakers employed in the pool are cylindrical (5 in. long, and about 4 in. in diameter) manufactured by Goodman Industries Ltd. Specially designed for underwater use, they will operate at any depth, and in practically all conditions.

Is this then the new fourth dimension, or does it mean that there is no longer the need to keep one's head above water.

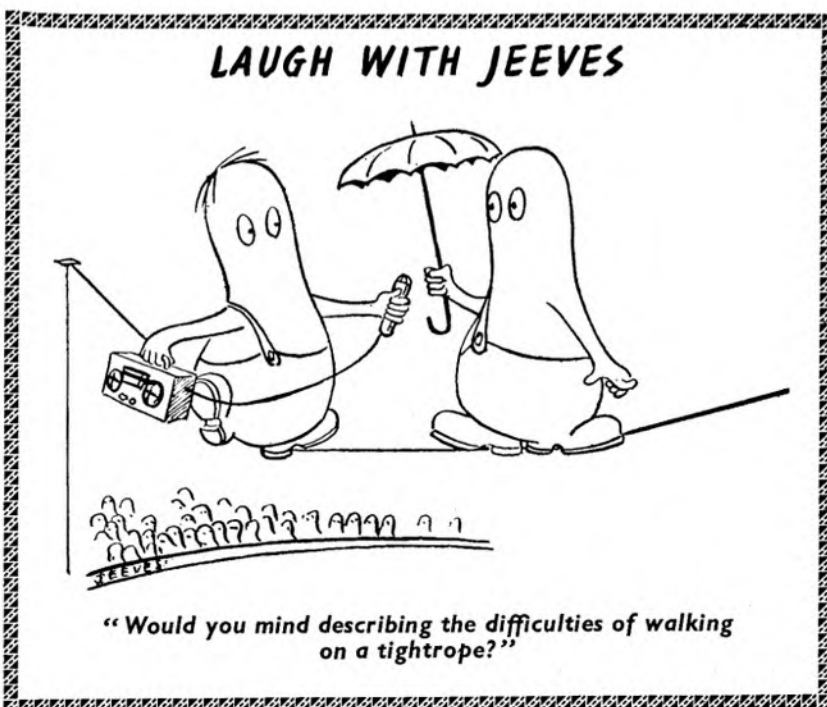



"Everyone's going Elizabethan," say the adverts by Elizabethan (Tape Recorders) Ltd. And this young man took it literally. He was in charge of the visitors' book at a Press party held in London recently to introduce the new range of four-track recorders. Before the party got under way, Elizabethan's Sales Manager, Mr. Newland-Smith, took the opportunity of showing the young man, Gerald Ford, the new range

THE WORLD OF TAPE

Triumph for Ampex

UST champion four-track stereo tapes

(NEW YORK)

FOUR-TRACK stereo tape has gained the support of the majority of the American recording industry. Now that Columbia Records, the last important hold-out, have been won over, the year-long campaign to launch four-track tape is successfully accomplished.

Three of the American industry's most important recording firms adopted the standard during July. In addition to Columbia, Capitol entered the field with 12 packages and RCA-Victor followed with 17, a dozen in the pop field and five classical.

It is a triumph for Ampex Audio who started United Stereo Tapes to serve as an international pre-recorded tape distributor a year ago.

It was a move by Ampex to stimulate sales by focusing the public's attention on one standard product. For dealers it provided a single source of supply for most labels pre-recorded tapes.

To the public it championed the cause of four-track tape and offered high-quality 7½ ips tapes at virtually half the cost of equivalent-time twin-track.

There were 13 labels co-operating with UST at first, nine of which produced their own tapes. UST manufactured four-track releases for the remaining firms and was responsible for the sales distribution and exploitation, under a co-operative agreement with them all.

There are now 700 different tapes available through UST in the U.S. They come from 30 different record labels and include the products of American Decca, London (British Decca's American subsidiary), Mercury and MGM.

Last spring the operation expanded to Europe with a large stock being maintained in Switzerland.

A rival organisation headed by Bel Canto was launched earlier this year. It attracted several other disc firms into a co-operative arrangement.

UST's sales in its first year are reported to have passed the £500,000 mark and this is expected to be doubled in the next 12 months.

Now that Capitol, Columbia and RCA have entered the American market the expansion is bound to be accelerated.

More than 500,000 four-track machines were manufactured in America during the last year. Virtually all new reproduction equipment includes the four-track facilities. The number of conversions there cannot be estimated.

NOT SO LONELY

SOUTH African student, Miss Fiona Grant's tape-recorded guitar playing kept London doctor, Mr. David Lewis, company on his way across the Atlantic when he finished third in the single-handed yacht race.

TAPE AIDS DEAF CHILDREN

MEMBERS of the Luton Amateur Operatic and Dramatic Society have been tape recording stories from children's set books along with appropriate sound effects. Their aim? To enable partially-hearing children at the local schools to gain a more realistic picture of the stories as they listen to them through their special earphones.

It's all part of a scheme by Miss Angela

Jeffreys, who was specially trained at Manchester University in aiding partially-deaf children, to allow such afflicted youngsters to grow up normally alongside their friends.

Readers may remember Miss Jeffreys from the last series of the B.B.C. "Sound" Programme when I. W. Jarman took her stage by stage through the mechanics and techniques of a tape recorder.

to the Battalions where there is a machine. Similarly, men abroad can record messages, send them to their relatives and the recruiting team can play them back as they reach the village or two concerned.

It is hoped by these means to publicise the activities of the regiments and at the same time strengthen the ties between soldiers abroad and their families at home.



THE fourteenth edition of *What Goes On Here*, a tape recorded magazine for the blind in Ilford produced by Walter and Ronald Gillings, included a ten-minute feature programme on the magazine which was broadcast in the B.B.C.'s Pacific Service to Australia.

An earlier edition of the magazine had included an interview with Alderman Tom Parker, the Mayor of Uxbridge, who has himself been blind since he was a boy.

A NEWS ROUND-UP

TAPE will play a big part in allowing people all over the world to see moving pictures of the Olympic games at Rome. An Ampex Videotape TV recorder will put visual and sound patterns on a two-inch wide strip of tape and these can be flown anywhere in the world where another recorder plays them back. In all 14 of these television recorders will be located in special recording studios around Rome.



IN order that serving members of the North Irish Brigade can keep in touch with their relatives, and their relatives with them, a tape recorder is to accompany the recruiting campaigners who are touring the towns and villages in the area.

The recorder will be used to collect messages, and the tapes can then be sent

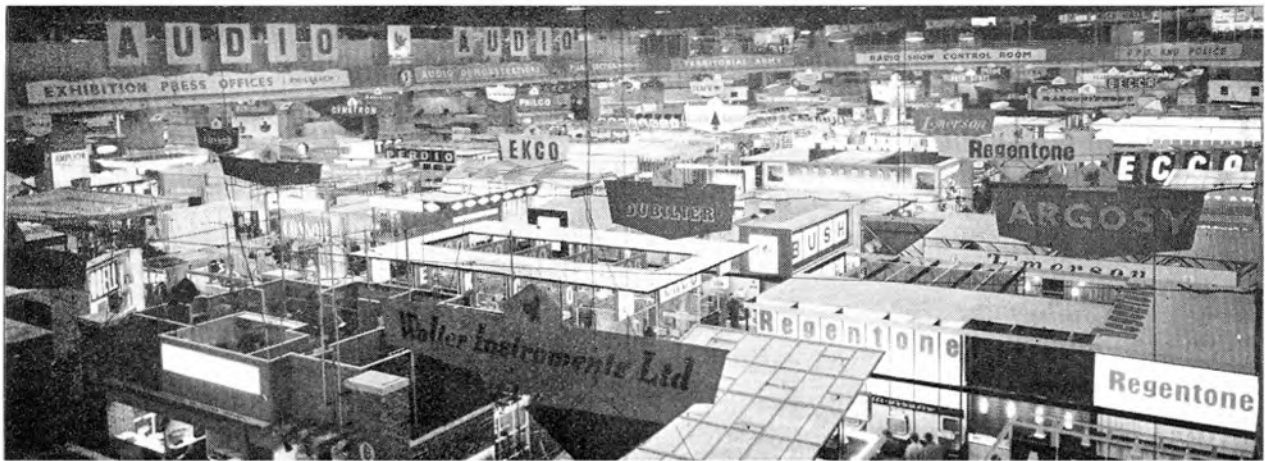

RADIO SHOW ROUND-UP

The Radio Show is over for another year and here we give a glimpse of the recorders seen for the first time at Earls Court. Although four-track seems to be the 'hit' of the show, the expansion of tape is vividly brought home by the introduction of recorders by well-established radio and television firms. These are the recorders, they can be seen at your local dealers.

WHILE some established tape recorder manufacturers are progressing into the field of four-track and others are exploring the possibilities of the ultra-slow speeds, the large radio firms are beginning to notice the worth of the tape recorder itself.

Wandering around the Radio Show we found that arranged, almost shyly hidden, among their well-known products in other spheres of electronics, a number of firms were introducing a domestic tape recorder.

Firms that are household names with regard to radio and television, including Ekco, Ferranti, Kolster-Brandes and the Co-op, introduced

their first domestic tape recorder.

Each of these new recorders is aimed at the popular market and, consistent with the lower prices for this sphere, without exception use the B.S.R. Monardeck as a basis.

Throughout the show indeed, low prices have been noticeable. Among the four-track single-speed models the enthusiast would not have to look far for a machine at 37 guineas (Sound Prince and Stella 454), or 39 guineas (Elizabethan FT 1).

Even the three-speed four-track models are not beyond the reach of the average enthusiast's pocket, with machines at 55 guineas (Elizabethan FT 3), and 59 guineas (Stella ST 455).

The half-track single-speed ($3\frac{1}{2}$ ips) recorders lower the prices even more, and the following specifications are a guide to the general standard.

One amusing note in the whole show is provided by the Co-operative Wholesale Society brochure which informs us that their recorder is "tax-free". However, their recorder price is even further reduced when it is borne in mind that the normal "Dividend" allowance available on all Co-op purchases is included.

Their single-speed recorder, the Defiant T 11, uses the B.S.R. Monardeck providing a maximum of three hours play on a $5\frac{1}{2}$ in. spool of double-play tape.

The facilities provided include mixing from microphone or radiogram inputs, pause control, fast wind-on and rewind, extension speaker socket for use with or without internal speaker operation, and a magic eye recording-level indicator.

The quoted frequency response is 60—8,000 cps, and the power requirements



Argyll Fidelity Minor

200—250 volts, AC, 50 cycles. Output is given as $1\frac{1}{2}$ watts. Consumption is estimated at 35 watts.

The T 11 measures $16 \times 12\frac{1}{2} \times 6\frac{1}{2}$ in. and weighs 20 lb. An Acos Mic 40, reel of tape and spare spool and spare set of plugs are included in the price of 28 guineas.

Available in an attractive red/grey or blue/grey carrying case.

The second new recorder, with the B.S.R. Monardeck, the RT 20, was introduced by Kolster-Brandes Ltd.

With a single-speed of $3\frac{1}{2}$ ips, the available playing time is the same as for the Defiant model.

Weighing 22 lbs within its $16\frac{1}{2} \times 13\frac{1}{2} \times 7\frac{1}{2}$ in. frame the RT 20 has a quoted frequency response of 60—10,000 cps, a four-stage amplifier, and a 7×4 in.



Defiant T 11



Ferranti RT 1044

elliptical speaker providing 2½ watts output.

The controls are limited to three simple operations. Volume with Mains on/off, wide range tone control, and, the standard Monardeck feature, joystick control with three active positions, record/replay, fast wind-on, and fast rewind.

The recording-level indicator is a magic eye.

Inputs are provided for microphone, and radio or pick-up, and output sockets for an extension speaker, or monitoring (for use with earphones or microphone used as earphone).

The Mains supply is 200—250 volts AC, 50 cycles. Storage space is available for microphone, spare leads and plugs, all of which are supplied in the price of 27 guineas.

The third B.S.R. Monardeck recorder is the Ekco RT 366. This uses the TD 2 deck and is supplied with an Acos Mic 40.

A frequency response of 90—8,000 cps ± 3 dB is quoted, and an output of 3 watts is claimed through the 7 x 4 in. elliptical loudspeaker.

With the single speed of 3½ ips, 90 minutes playing time is provided on a 5¼ in. spool of standard tape.

The facilities include magic eye recording-level indicator, extension speaker sockets with internal speaker cut-out, and alternative high or low sensitivity inputs for microphone or radio/pick-up.

A spare input cable, reel of tape and take-up reel is also included in the price of 28 guineas.

Dimensions are 13¼ x 11¼ x 7½ in., and the weight is 22 lbs.

The Ferranti company, well-known for their other electronic products, entered the tape recorder field with the 28 guineas RT 1044 recorder.

Equipped with the B.S.R. type T.D.2 deck, the RT 1044 offers a single speed of 3½ ips and gives up to 1½ hours playing time on a 5¼-in. reel of standard tape. Output is rated at 2½ watts for the internal 7 x 4 in. elliptical speaker, and 3 watts for an external speaker.

There are four controls: record/play, tape mechanism, recording level/volume, and tone/on-off. A magic eye is fitted and there is a special compartment at the rear to house the Acos Mic 40 which is supplied with the recorder. High or low sensitivity inputs for microphone or radio are incorporated and there is a muting switch for the internal speaker. A spare input cable with jack plug attached is provided for connecting to a radio.

Styled in coffee/beige or blue/grey, the recorder weighs 22 lb. and measures 14¼ x 7½ x 12 in.

Another newcomer first viewed at the show is the Redicord-Reditape costing 34 guineas with microphone.

The Reditape uses the Garrard magazine-loaded deck and with a single 3½ ips speed. Designed to operate at 225-250 volts A.C., the recorder has a wow figure claimed as better than 0.2 per cent R.M.S. and a flutter figure as better than 0.1 R.M.S. Frequency response is quoted as 30-7,000 cps and maximum spool size is 4 in.

Fidelity Argyll announced two new models, the Minor at 22 gns. and the four-track model at 31 gns.

The Minor uses the B.S.R. deck and gives up to 2 hr. 8 min. playing time,



Amplion A224A

using the single 3½ ips speed and a 5¼-in. reel of LP tape. Frequency response is rated at 60-8,000 cps and the signal-to-noise ratio as 50 dB down. Wow and flutter are said to be 0.4 per cent R.M.S. The amplifier has a quoted output of 3 watts in a 8 x 3 in. high flux speaker.

A crystal microphone is supplied and there are input sockets for microphone and radiogram. An internal loudspeaker socket is also fitted. An automatic locking device prevents accidental erasure. Dimensions are 14¼ x 11½ x 5⅝ in. and the unit weighs 16 lb.

Apart from giving 4 hr. 16 min. playing time with a 5¼-in. reel of LP tape at 3½ ips, the four-track model also has facilities for mixing, superimposition and monitoring.

Frequency response is given as 60-10,000 cps and signal-to-noise ratio as 50 dB down. The output through the 7 x 4 in. high flux loudspeaker is rated at 4 watts.

The input sockets for microphone and radiogram are each fitted with their own compensation and variable controls. The recorder measures 17 x 13 x 7¼ in. and weighs 21 lb.

Right: The Kolster-Brandes RT 20, single-speed recorder with the B.S.R. Monardeck, price 27 guineas

Below: Again with the Monardeck, the Ekco RT 366, priced at 28 guineas





NATIONAL
TAPE RECORDING
CONTEST
CONGRATULATIONS
TO MR. N. PAUL OF
MUSWELL HILL ON HIS
PRIZE WINNING TAPE.
HE USED A
FI-CORD

Only with **FI-CORD** can you have it both
ways—really HI-FI and really portable

Don't be misled by the compact size. The **FI-CORD** is a high fidelity instrument of advanced scientific design—assuring true-to-life recordings.

Frequency 50-12,000 c.p.s. ± 3db. Tape speeds 7½ i.p.s. and 1½ i.p.s. Twin track record/playback, using standard 3¼" spools.

Wherever you go, you can take your **FI-CORD** with you, it is ideal for adding

the realism of sound to movie films.

The **FI-CORD** weighs only 4½ lbs., measures 9½" x 5" x 2¼", operates in any position (lid open or shut) and requires no power point. It runs on 4 batteries, rechargeable from the automatic charger supplied.

Built-in speaker. Full playback volume. Extension speaker socket. Dynamic microphone with stop/start switch.

**CATCH IT—
AND KEEP IT—WITH**

FI-CORD

Complete with
Microphone, Tape,
Batteries and Charger **59** GNS

or with Grampian DP4/M
Microphone **66** GNS

G. & G.

Write for name and address of your nearest stockist to:—

FI-CORD Ltd · 40a Dover St · London · W1

Tel: HYDE PARK 3448

Results of the British Amateur Tape Recording Contest, 1960

The Tape of the Year

"The Rest is Silence," a tense fifteen-minute drama of a condemned man's last hours before going to the gallows, by Norman Paul, Esq., aged 44, of 41, Woodland Rise, Muswell Hill, London, N.10.

AWARDS

The Emitape Cup presented by E.M.I. Sales and Service Ltd.
Truvox 6 recorder presented by Truvox Ltd.

Equipment used: Ferrograph recorder, Emitape, Elon-Collaro recorder, Fi-Cord portable, Film Industries and Gramplan microphones, Bib splicer.
Runners-up: "Ban the Phon" and "Our School."

Compositions

"The Rest is Silence," by Norman Paul, Esq., (see above).
Runner-up: "Ted's Ten Thousand," by G. A. Theakston, Esq.

Documentaries and Reportage

"Morning Departure," interviews and sound collection at Manchester's Ringway Airport, by J. Radford-Evans, Esq., aged 44, of 60, South Drive, Manchester 21.

AWARDS

Chitnis 9/S4K stereo recorder presented by
Chitnis Electronics Ltd.
Tape Recording Magazine Ten-Guinea Cheque
Certificate

Equipment used: Simon SP/4 recorder, Soundrite Tape, Lustraphone microphone, Acos microphone (splice-free).
Runner-up: "Child in a Thousand," by Miss M. Jeffreys.
Highly Commended: "Pilgrimage to the Sea," by Nigel Rees, Esq.

Music or Speech

"Beat'n Heart," electronic music in the modern idiom, by R. P. Guttridge, aged 31, of 20, Isis Drive, Upminster, Essex.

AWARDS

Acos Cup presented by Cosmocord Ltd.
Six reels of BASF LP tape presented by
F. A. Hughes and Company Limited
M50 TR Chitnis microphone donated by
Chitnis Electronics Ltd.
Tape Recording Magazine Ten-Guinea Cheque
Certificate

Equipment used: Ferrograph recorder, Agfa tape, Reslo Ribbon, Gramplan DP/4, Lustraphone microphones.
Runner-up: "Home by Starlight," by G. Fitzgerald, Esq.
Highly Commended: "Impressions by a River," by W. A. C. C. Smith, Esq.

Actuality

"Lydd Carnival Fireworks Night," by Michael Pollock, Esq., aged 19, of 13, Island Road, Mitcham, Surrey.

AWARDS

Set of four-track stereo/mono Bogen heads donated by
Gopalco Ltd.
Six reels of BASF LP tape donated by
F. A. Hughes and Company Limited
Tape Recording Magazine Ten-Guinea Cheque
Certificate

Equipment used: Stuzzi Magnette, Scotch Boy tape, AKG D.19 microphone.
Runner-up: "The New Shoe," by R. A. Margoschis, Esq., and "Birth of Kittens," by J. Leeming, Esq.



Lady Ian Jacob presents the Emitape Cup for the "Tape of the Year" to Norman Paul at the Emitape luncheon

Technical Experiment

"Nuclear Madness," electronic variations on an atomic bomb theme, by R. O. Broome, Esq., aged 31, of 145, Sprotborough Road, Doncaster, Yorks.

AWARDS

Wyndsor Gold Medal donated by Wyndsor Recording
Co. Ltd.
Set of two-track mono Bogen heads donated by
Gopalco Ltd.
Tape Recording Magazine Ten-Guinea Cheque
Certificate

Equipment used: Collaro tape deck and pre-amp, Scotch Boy tape, Telefunken microphone, Bib splicer, home-constructed mixer unit and other home-built equipment.
Runner-up: "Background for a Drama," by Nigel Rees, Esq.

Clubs

"Ban the Phon," a good-natured satire on the nuclear disarmament campaigners, entered by D. J. Garrett, Esq., aged 19, of 186, Hunt Road, Higham Lane, Tonbridge, Kent, on behalf of himself, R. R. S. Gouldsworthy, Esq., and P. Tucker, Esq., both aged 19.

AWARDS

Amphlett Shield donated by John Amphlett, past President
of the Federation of British Tape Recording Clubs
M62T microphone donated by Chitnis Electronics Ltd.
Six reels of LP Mastertape donated by M.S.S. Recording
Co. Ltd.
Tape Recording Magazine Ten-Guinea Cheque
Certificate

Equipment used: Two Gramdeck tape tables used on Chancery turntable and Collaro Junior turntable, and two Gramdeck pre-amplifiers, Emitape, two R.S.C. (Leeds) Ltd. A7 amplifiers, two Lustraphone LD/61 moving-coil microphones, and numerous home-built devices, including tape splicer and parabolic reflector.
Runner-up: "Day at a Public School," by J. Shuttleworth, Esq.

Schools

"Our School," a school magazine in sound, by Stanground V.C. Primary School (Master-in-charge: P. J. Kingston), Peterborough.

AWARDS

Grundig Cup donated by Grundig (Great Britain) Ltd.
Six reels of Agfa PE 31 tape donated by Agfa Ltd.
Tape Recording Magazine Ten-Guinea Cheque
Certificate

Runner-up: "School Magazine in Stereo Sound," by J. Shuttleworth, Esq.



THE JUDGING

“This is not a pretty story . . .”

By R. N. ROBINSON

THE afternoon's judging had been surprisingly hard work and the judges had experienced over two hours of intensive listening. Remarks—witty and cogent—had been passed about during and after the tapes were played. Tea had been served and everyone was waiting for the next tape.

“This is not a pretty story . . .” was the opening statement of Norman Paul's “The Rest is Silence,” and for the next 13½ minutes the speakers gave forth a tightly woven playlet of a youth whose life was to end on the gallows.

It wasn't a pretty story, but it certainly riveted the judges to their seats. For several seconds after the tape finished there was, in fact, silence, followed by fervent praise. In comparison to everything that had gone before, this was obviously THE tape of the year, and despite the high standard of the tapes that followed, the choice was obvious.

“Were they all amateurs?” asked one of the judges wonderingly, questioning the immaculate cutting, timing, acting and general conception of the tape. Assured that the entry was entirely amateur, the praise increased.

Thus, Norman Paul became the winner of the Emitape Cup as the entrant with the most outstanding tape of the competition.

In direct contrast to the judging on that occasion was the 15 minutes of pure joy from Stanground V.C. Primary School in the Schools' section.

The liveliness and spontaneity of the children was irresistible. It made a terrific impact on its audience and produced shouts of laughter and cries of admiration. Eric Robinson, a professional musician, bowed his head in amusement as the children hammered their way through an item by the school percussion band.

Once again, something genuine had been caught on tape and there were no dissenters as to who the prizewinners should be in this section.

Runners-up were a Welsh school who ambitiously presented a magazine of their school in stereo.

A close-fought section was Actuality. Here, apart from the winning tape, there were two excellent entries which finally ended as joint runners-up.

R. A. Margoschis had collected an impressive array of sounds on his tape, entitled “The New Shoe,” which depicted the shoeing of a horse at the

(Continued on opposite page)



THE JUDGES

The final judging of the Contest was carried out by a distinguished panel of judges composed of, left, reading down, Sir Ian Jacob, former Director-General of the BBC, Mr. Eric Robinson, television band-leader, Mr. Robert Milne-Tyte, Educational correspondent of the *News Chronicle*, and, below, Miss Josephine Douglas, television personality.

Initial hearing of the tapes was carried out by members of the Federation of British Tape Recording Clubs, above, left to right, Freddie Westcott, Chairman, Alan Stableford, Secretary, Ken Blake, and Roger Aslin.





THE SAVOY LUNCH

Some of the winners, judges, E.M.I. representatives and guests seen at the Emitape luncheon at the Savoy Hotel, London.

blacksmith's, while J. Leeming had some good on-the-spot recordings of kittens immediately after birth, being "talked to" by the mother cat.

The prize went to M. Pollock for his realistic tape of fireworks and fun at Lydd Carnival. Accuracy of sound reproduction was the keynote here. Considering the wide variety of sounds captured—rockets going off, "bangers" exploding, people laughing and talking—the final picture was remarkably undistorted.

A close contender for the "Tape of the Year," which eventually gained runner-up position, after being awarded first place in the Club section, was "Ban the Phon," submitted by G. J. Garrett on behalf of a group of people.

The basis of the tape was a good-humoured satire on the "Ban the Bomb" marches, except that the marchers wished to see the "phon" (a unit for measurement of sound, for the uninitiated) abolished. Here again the fade-ins and fade-outs were superbly judged and the variety of different voices and sound effects used was very impressive.

It certainly amused the judges, possibly because the nonsensical campaign, nevertheless, had its roots in reality and the backgrounds, however crazily used, were authentic. The comic effect was further heightened by small incidents of madness, not necessarily connected with the story, dotted here and there throughout the tape.

R. O. Broome used something like the same theme for his winning entry "Nuclear Madness" in the Technical Experiment section. The subject was treated seriously and a catalogue of weird and suggestive sounds ended with a distorted and depersonalised voice announcing a "count down" followed by what sounded like the daddy of all nuclear bomb explosions—a sustained roar which continued for several seconds.

A prizewinner in past years, Nigel Rees had submitted a series of abstract sounds as a suggested background to Macbeth. His tape gained runner-up position.

The Music or Speech section was won

by an intriguingly original composition entitled "Beat'n Heart," by R. P. Guttridge. It was music, but the sounds which comprised it seemed not those of everyday instruments. In the background a regular beat was established by an effect which sounded very much like an electronically amplified heartbeat. If the word "melody" can be used in such a context, it seemed as though it was being played on some device very much akin to a Jew's Harp. Certainly, a very compelling piece of tape ingenuity.

Competing strongly with "Beat'n Heart" was "Home by Starlight," by G. Fitzgerald. This was a straightforward song with a pleasing tune, attractive lyrics and a normal musical accompaniment. It was tunefully sung and the recording technique was near professional.

Another closely-run section was Documentaries and Reportage. This was finally won by J. Radford-Evans'

"Morning Departure," an expert piece of interviewing and sound collection at Manchester Airport. This was a model B.B.C.-type interview programme and the microphone was wielded with confidence. It topped the section because it was by Mr. Radford-Evans' efforts that his subject had become interesting.

A subject which was interesting in itself was provided by "Child in a Thousand"—the problem of parents who have deaf children. Miss M. Jeffreys' tape, which was runner-up in this section, recorded talks with such parents, and the problems which they run up against in life. No attempt had been made to channel the parents' replies and there was a good deal of integrity in the finished product.

That then was the 1960 British Amateur Tape Recording Contest. Entry numbers were up and, according to those who were able to compare it with the previous year, the standard was up also.



Left to right: Sir Ian and Lady Jacob, Mr. H. A. Lewis, Managing Director of E.M.I. Sales and Service Ltd., Miss Josephine Douglas, Mrs. H. A. Lewis, and Mr. P. H. Wetherill, Sales Manager of E.M.I. Sales and Service Ltd.

THE WINNERS



Mr. Norman Paul

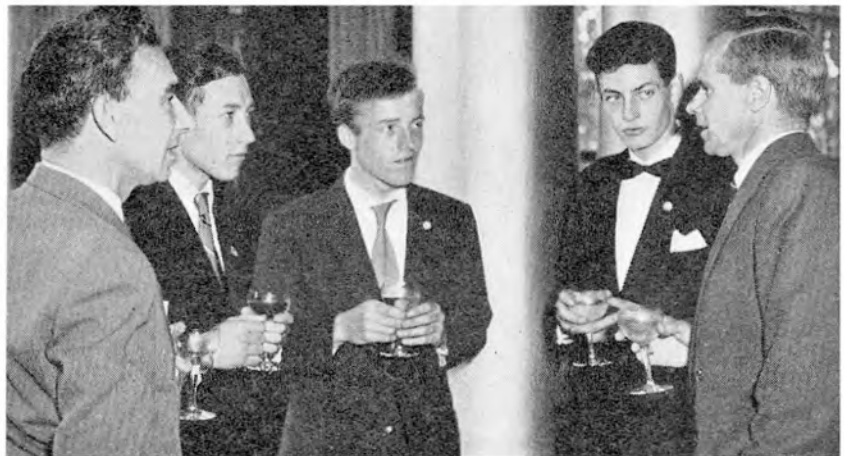

E.M.I. and the Club Section winners. Mr. D. J. Garrett, Mr. P. Tucker and Mr. R. A. S. Gouldsworthy, who made the brilliant "Ban the Phon" tape, discuss their success with Mr. John Wooller (left) and Mr. Peter Wetherill (right) of E.M.I. Sales and Service



Above: Mr. J. Radford-Evans and below, Mr. P. J. Kingston

The 1960 Contest produced many new ideas—and an entirely new set of faces. All the winners were collecting prizes for the first time.

Mr. Freddie Westcott, Federation Chairman, presided at the special function at the Radio Show at Earls Court, at which awards were presented by Miss Jo Douglas. He recalled that, in earlier contests, the same names cropped up in the prize lists year after year.

This year, as the Contest took a big stride forward, newcomers challenged the old hands—and scored all the successes.

(Continued on opposite page)



Above: Mr. R. P. Guttridge and below, Mr. M. Pollock



Left: Mr. R. O. Broome

... AND THEIR TROPHIES

"The quality and quantity of the tapes entered proved the increasing popularity of the Contest," Mr. Westcott said.

The photographs on these pages illustrate the wide age range of the winners—from 19 to 59.

This year, too, there was a more exciting range of prizes than ever before—including three silver cups, a gold medal and a shield.

After the presentations, there was a public playback of the winning tapes.

Earlier in the evening, prize-



Mr. A. Bradshaw receives the Grundig Cup for the Schools' Section on behalf of Mr. Kingston



Right: Mr. D. J. Garrett receives the Amphlett Shield for the Club Section winning tape *Ban the Phon*. Above: Mr. Norman Paul receives the Truvox 6 recorder, another of his prizes for the "Tape of the Year."

Below: The Acos Cup is presented to Mr. R. P. Guttridge for his tape *Beat'n Heart*



winners, judges and many leading representatives of the recording industry were guests of *Tape Recording Fortnightly* at a cocktail party at Earls Court.

The best tapes from the Contest will now go forward as the British entries in the International Contest (tapes), judging of which takes place in Holland at the beginning of November.

Mr. Norman Paul, who produced the "Tape of the Year" will be going to Amsterdam with the British delegation, thanks to the generous interest of a leading British manufacturer.

THE RECORDING ROOM

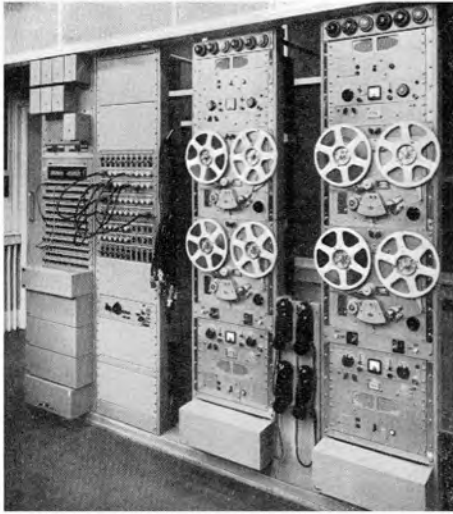

ALEC NISBETT concludes his present series of articles describing the techniques of recording used at the B.B.C. The recording room and editing block is the last of:

THREE LINKS IN A CHAIN

Four of the sixteen E.M.I. TR/90 rack-mounted tape recorders in the Central Tape Recording Room at Broadcasting House. Recordings made here are monitored either in the studio (in the case of simple talks) or in a special listening room

*Photographs by
courtesy of the
BBC*

WHEN a B.B.C. studio recording is made the first rule to be observed is that the recording must be monitored by replay as it is being made. It's no good finding a fault ten minutes after the artist has left the studio. And in general the programme is heard twice; firstly by the studio manager who is continuously judging the sound picture that he is creating, by listening to his studio output; and secondly by the recording engineer who is checking the quality of the recording.

Between these two there is a delay of a fifth of a second: three inches between record and reproduction heads, at 15 ips. And this is more than enough to make it highly unsatisfactory for the two jobs to be rolled into one (the studio manager monitoring the output from the recorder) in any but the simplest of cases, such as talks.

A fifth of a second doesn't sound very much, but in fact it's quite enough to destroy a studio manager's sense of timing completely. The perfect fade on a piece of music, for example, may have to be accurate to within a twentieth of a second. Nobody's reactions are as fast as that, of course, this sort of thing depends on anticipation and a sense of rhythm.

These requirements mean that as a general rule there must be three acoustically separate rooms: the studio, its control cubicle, and the recording room.

The most obviously convenient layout is to have the three permanently grouped together as a suite, and one practical result of this might be that a play could be rehearsed and recorded scene by scene.

But in fact, the shape of a programme, its dramatic contour, is likely to be better if it is rehearsed and recorded as a whole. And this being the case, a more economic arrangement is to divide studio time into two parts, with the recording session limited to a relatively short period. For example: "Under Milk Wood" had five days rehearsal and was recorded in part of an afternoon.

There are various other arrangements, such as that used for "Roundabout," where one or two of the last-minute items may be recorded in the control cubicle, with the recording engineer monitoring on headphones for an immediate check, and subsequently on the loudspeaker if time allows.

But if you attend a BBC recording, you are most likely to see a fairly standard procedure:—

At the end of the rehearsal, and a few minutes before the scheduled recording

time, the studio manager will ring up the recording room on the "control line" (a "control line" is an ordinary narrow-band telephone circuit, so called to differentiate it from the "music line" along which the programme is fed). Details of the recording will be checked, and the equipment lined up on a standard 1,000 cps tone which is sent by the studio; meters will be checked and some of the tone recorded on the tape, so that this process can be repeated when the tape is replayed.

Then "level" will be given: someone in the studio will read a few lines. This gives the recording engineer an additional check on quality—it's the last he will hear direct from the studio.

A quick check that everybody is ready, and then the studio manager says, "We'll be going ahead in ten seconds from . . . now!" He switches on the red light, takes a last swift glance round, fades up the studio, flicks the green cue-light . . . and away we go.

Perhaps the most vital work in that routine is the "now" it all happens in ten seconds from. The stories of people who forgot the operative word are many and sad!

At the end of the recording comes the reckoning: checking the duration, and are there any retakes? A faulty intonation here, perhaps; an effect obscured by dialogue there—standby for another cue. Then it's in the bag. Mark it "To be edited."

BRITISH BROADCASTING CORPORATION TITLE "SOUND" EDITION 33 REF NO TLO

THE RECORDING ROOM

ALEC NISBETT concludes his present series of articles describing the techniques of recording used at the B.B.C. The recording room and editing block is the last of:

THREE LINKS IN A CHAIN

The editing session in this case would be very short: cutting in the retakes, perhaps a fluff to be taken out, or a cut for time.

But where the editing channel really comes into its own is in the field of unscripted discussions and talks features.

It's a pretty safe bet that in any discussion between any but the most fluent (and at the same time concise) speakers, people are likely to get off the subject, repeat themselves, stammer, hesitate, cough, labour trivialities, and inadequately stress the essentials.

No discussion that is to be any good can be scripted; on the other hand a lot can be done by careful planning, and a skilled chairman. But an unpractised speaker generally talks best when he is allowed to relax and "get on with it." It's then up to the producer of the programme to interpret what the speaker has to say by giving his talk shape, by finding the essentials of what he has to say, by cutting, transposing and tightening.

The actual work is usually done on one of the three large professional machines with which most editing channels are equipped. Also in the room there may be other equipment, such as a variable correction unit which has tone controls and filters, and a device for varying the supply frequency, so that the synchronous motors of the recorders can be varied in speed—both of these are for use in copying to correct faulty tapes.

There may be disc cutting machines,

Transfer of recordings from tape to long-play disc for the BBC Sound Archives. This is the one case where a recording is not monitored at the time that it is being made: the weight of the stylus would damage the groove profile. The tape is being played on an E.M.I. BTR/2.

All BBC tapes are identified on the leader, as shown in the illustration across the foot of the page, as soon as the tape is made—a practice amateurs might copy. The box is also identified by title and number and a very full documentation is kept with the tape. "TLO" stands for Tape, London.



and possibly also record players. A half track-head with variable azimuth will be available and can easily be fitted. Speeds of 7½-15 or 15-30 ips will be available on each machine. There will certainly be a high-quality loudspeaker. But one of the most important facilities will be the simplest—the editing block.

This block is fixed to the deck, and has a channel which is slightly lapped at the edges to grip the tape, and a diagonal groove to guide the razor blade. An inch of jointing tape is sliced off a roll and stuck in place by hand: the whole operation is manual, and with practise, each joint can be marked, cut, spliced and monitored all within a very few seconds.

A dusting of french chalk is also sometimes recommended, but in practise this is not always necessary. The jointing tape is slightly narrower than ¼ in. and the adhesive is non-oozing, so that it has to be a very bad joint to be "sticky"—and in any case, every edit is heard

through afterwards, so that any fault should show itself—and a bad joint can then be remade.

Incidentally, not every edit is best made by a straight cut. Often levels will have to be corrected, in which case copying will be necessary; and sometimes a mix is wanted, so that all three machines will be used.

And once again the important qualities are skill and speed—absolutely essential when many programmes (such as "Sound," quite often) may have more than a hundred joints in a half-hour of tape.

In broadcasting there is one commodity that is more expensive than any other—time.

And this is where the amateur has the advantage over the professional.

In my last article, I said that the BBC is now using a "moving-coil" pick-up in its latest record player. I am sorry, my mistake, it is in fact a Tannoy variable reluctance moving-iron pick-up.

TLO19091 REEL 1 OF 1 TOTAL DURATION 28'55" SPEED 15 INS-SEC DATE 12.6.50



The man who knows what's inside says:

You get more out of TELEFUNKEN

TELEFUNKEN Magnetophon 75K-15

TWO TAPE SPEEDS $3\frac{1}{2}$ ips and $1\frac{1}{8}$ ips

FREQUENCY RANGE 60-16,000 cps at
 $3\frac{1}{2}$ ips and 60-9,000 cps
at $1\frac{1}{8}$ ips

PLAYING TIME 6 hours 20 minutes
($5\frac{1}{2}$ " DP tape at slow speed)

Press button controls. Extra-sensitive braking and tape tension control system.

Recording head with ultra-fine gap. Indirect flywheel drive. Fast rewind, quick stop button. Digital counter. Automatic tape-end stop. Connections for earphones, remote stop/start control and extension speaker. In attractive lightweight Styron Case.

PRICE: **52 GNS**
(excluding microphone)

TELEFUNKEN Magnetophon 75T-15

Table model with output stage only. PRICE: **45 GNS**
(excluding microphone)

TELEFUNKEN Magnetophon 85KL

Six watts push/pull power stage, two matched oval speakers with cut-out switch, volume control, and separate bass and treble tone controls. Monitoring through loud-speaker or earphones while recording. Straight through amplifier facilities. Magic eye level control. External speaker connection. Continuously variable trick control can be fitted. In luxury case.



PRICE: **79 GNS**
(excluding microphone)

and the amazing

TELEFUNKEN Magnetophon 76K

Over 12 hours playing time from one $5\frac{1}{2}$ " DP Tape—4 track selection and super-imposition facilities.

PRICE: **64 GNS**
(excluding microphone)

A full selection of Telefunken Accessories, Microphones and Telefunken tapes are available. Ask for free brochure.

TELEFUNKEN

The originators of Tape Recording

SEND COUPON for details of the complete range to:

WELMEC CORPORATION LIMITED
147-148 STRAND, LONDON, WC2

Name

Address..... TRG

A SLIGHT CASE OF MURDER

By Dorothy Nixon

IAN WATSON turned from the mantelpiece against which he had been leaning, and faced the inspector.

"I agree this is a terrible crime." He spread out his hands, and shrugged his shoulders. "But really, I fail to see how I can help you."

The solid little man in the plain suit answered patiently. "We're only making routine inquiries, sir. Trying to trace the girl's last movements, and establish the people she may have met yesterday evening. I understand you were a friend of Miss Frayne's?"

Watson studied the lighted end of his cigarette. "At one time I wanted to marry Linda. But that's ancient history. For the last year, we've been good friends—nothing more." He looked cynically at the dark young man taking shorthand notes. "Am I going too fast for you?"

The younger policeman raised his head and replied stiffly, "Not at all, Mr. Watson."

Inspector Black intervened, "What happened to change your relationship with the murdered girl?"

"Shall we say that we both decided to call it a day?"

"There was no quarrel, sir?"

The eyebrows in the handsome face rose quizzically. "The flame went out, Inspector, and we were left with the ashes." He stubbed his cigarette emphatically, and smiled grimly to himself.

"I see," said the policeman thoughtfully. "Could you give me a detailed account of your movements yesterday evening, Mr. Watson?"

"I arranged to meet Linda about seven. We had a meal in the Italian restaurant round the corner, then we went to her flat to collect some letters I had written to her.

"They were sent when I was in rather an emotional state of mind, you understand, and I wanted to burn them."

Inspector Black stopped studying the design on the carpet, and inquired softly, "At approximately what time did you leave the restaurant, sir?"

"Oh, about eight-thirty, I suppose. You could check with the proprietor."

"We intend to do so. To resume, after you had reached the flat?"

"We had a drink for old time's sake, she gave me the letters, and I



left about nine o'clock. I passed her fiancé in the corridor, wished him luck, and went down in the lift. He can corroborate that."

"He already has, Mr. Watson. It appears that Mr. Graham was the last person to see Miss Frayne alive, except of course for the murderer. Time of death has been established at ten-thirty p.m. When you arrived home sir, at nine o'clock, what were your movements?"

Watson ran his hand through his hair and said slowly, "Nothing, Inspector. I read a book, had a bath about ten-thirty, and went to bed. My neighbours can probably confirm the time, as I usually sing in the tub. I make the devil of a racket as a matter of fact."

"Just one last question, sir. Could you give me an idea as to how the furniture in Miss Frayne's room was placed last night?"

The heavy brows knit in an effort to concentrate. "Well, the settee was in front of the fire, and the easy chairs had been placed with their backs to the window." He looked warily at the Inspector. "Is that what you wish to know?"

"That's precisely what we wish to know, Mr. Watson. You see, after

you had left the first time, and Mr. Graham arrived to visit Miss Frayne, she asked him to help her rearrange some heavy furniture. He then placed the settee in front of the fire, and the easy chairs with their backs to the window. You described the situation, when you saw it on the second occasion, at the time of the murder."

Watson's face paled. "Circumstantial evidence. You can't prove a thing."

But the prosecution could, and did.

In court, Watson maintained that he had been at home during the time of the murder. His alibi was upheld by his neighbours, who claimed to have heard a voice singing, as well as the sound of water running into the bath.

His case finally collapsed, however, when a tape-recorder was produced, and played back to the jury an interesting recording of a man singing in his bath, complete with splashes and noises off. It was shown that while the tape-recorder gave its performance, Watson had returned to the flat by the fire escape, and murdered his former girl friend. If he couldn't marry her, then no other man would either.

There is no fury like a woman scorned—unless it be a man.

Dangers and advantages in the use of four-track

THERE are dangers as well as advantages in the advent of a wide range of four-track recorders on the market. Although some of the machines may not have been designed specifically for stereo use they all lead towards it by virtue of the fact that the extra heads needed for the extra tracks can be used very conveniently for creating a stereo system.

This is a progressive thing, but such is the human mind that this coincidence could well give rise to a belief that stereo and four-track reproduction are *automatically* ideal for each other.

This would be far from true. It is quite likely that four-track stereo will become the accepted formula ultimately, and it is quite true that some machines have already reconciled the two happily. In the meantime, however, there is no escaping the fact that stereo exists solely for the purpose of improving the quality of reproduction, while the four-track movement is intended to achieve economy of tape consumption, even if quality has to be sacrificed to some large or small extent.

Unquestionably, the latter movement is accompanied by tremendous efforts to avoid too great a sacrifice of quality, and in some cases the battle to compensate for the natural worsening of the signal-to-noise ratio situation has been completely successful; but the point we need to remember is that unless this particular battle is won—and unless we are prepared to pay a little extra for the victory if necessary—then we are in danger of losing almost as much quality of reproduction through the narrow track as we have gained through adopting two channels and two speakers.

The long and short of it is that the decision to acquire stereo only makes complete sense if we are prepared to be faithful in every way to the standard it implies. It follows that one should make sure that any four-track machine that is to be used for stereo has a satisfactory signal-to-noise ratio and is free from other troubles which might be expected to arise from the adoption of the narrower track.

Fortunately, one of the important factors—tape efficiency—can go on improv-

ing regardless of what machine one buys. Tape quality plays a big part in this movement towards the narrower track, because a small defect that may be masked by the wide track can produce a total drop-out in the case of the narrow track.

When four tracks are accommodated on a normal tape each track is reduced by more than half because of the demands made by the two extra safety lanes. This accentuates the drop-out problem as well as that of signal-to-noise ratio.

If you approach the four-track innovation with your eyes and ears open and take care that you are not weakening a link in the standard of reproduction that you have set yourself, then you will be able to benefit from the economies it has to offer.

* * *

Bright future for stereo concerts

I HAVE always felt that stereo represents a break-through from the conception of reproduced music as something divorced, in time as well as space, from the real thing, to a performance that retains much of the impact of a live concert taking place here and now.

For this reason, I believe that there is a bright future for stereo concerts taking place in a hall properly fitted up with first-class equipment. More people, far more, will sit and listen to a stereo concert than would do so for monophonic reproduction—not just because the quality is better but because their listening faculties are fully engaged.

I note that the new Holborn Library has a sizeable concert hall fitted with stereo equipment, and if this is a success we shall probably find that other centres will follow their example.

Regular concerts, given with the co-operation of the recording companies, would be an ideal way of demonstrating the value of new stereo recordings, since the facilities in most retail establishments are usually inadequate from the point of view of judging how much or how little true stereo there is on a disc or tape.

Equipment

THE

THE Stuzzi "Magnette" battery tape recorder type 671B is a fully transistorised portable tape recorder requiring no external power supplies.

The sample submitted for review was contained in a plastic ever-ready case which has a sturdy shoulder strap and a useful pouch for accessories. This plastic case is an optional extra. The weight of the recorder is 8 lbs., in case and with accessories 10½ lbs.

The standard equipment supplied comprises the recorder, 450 ft. reel of tape and an empty reel. There is also a moving coil microphone with approximately 7½ feet of insulated screened cable, an adaptor cord approximately 3½ ft. long complete with plugs and sockets, for transcription purposes, a carrying handle for the recorder proper, and the operating instruction booklet which can all be comfortably accommodated in the zip-fastened pouch in the optional carry-case mentioned earlier.

The machine can be operated within this case since there is a perforated area of approximately 3½ x 2½ inches in the rear panel, opposite the loudspeaker aperture, and a flap fastened by three press studs gives access to the control panel on the top of the instrument.

Alternatively, the machine can be removed from the case quite simply by loosening one buckle which removes a strap beneath the bottom of the recorder body and sliding the ever-ready case away from the machine.

The tape recorder itself is an attractive-looking little machine, measuring 11 x 8½ x 4¼ inches overall, tapering towards the top. The front of the machine contains a perspex panel measuring 9 x 5½ inches through which can be seen the spools and also the battery state indicator. Access to the spools is obtained by removing this perspex panel. The spools are retained in position by a small disc measuring 1¼ inches in diameter, having a threaded centre which screws on to the drive-shaft for the spools. This locking disc has a small finger depression to enable it to be screwed or unscrewed without difficulty. It will be appreciated that spool changing on this machine is a very simple matter.

It has already been stated that the recorder is completely portable and requires no external power supplies, the motor in fact is battery powered, making use of two 4½-volt flat torch batteries. It is clearly important that the state of these

Sound Effects

By Alan Edward Beeby

"It seems," said the Editor recently, "that a number of our readers are becoming interested in the use of 'mood' music in their recording activities." He tapped his pen on a pile of opened letters on the desk. "Quite a large number, in fact," he continued, "and following our usual policy of giving the readers precisely what they ask for, I thought we might run an article on the subject."

So far as I was concerned, "we" was the operative word. True, I have, over the past few years, made constant use of "mood" music items in my work, but I felt that, as an introduction to the subject itself, the readers were entitled to a more experienced review than one which has, doubtless, become coloured through personal tastes and preferences. So, I took my troubles along to Mr. R. C. Denton of the Conroy Recorded Music Library.

There are, Mr. Denton told me, a total of twelve music publishers' recorded music libraries consisting of specially-recorded music by all sizes and types of orchestras to accompany every possible dramatic situation. This music embraces an extremely wide range, from "Bridges" lasting a mere three seconds, to full-length items of three minutes or over.

The libraries are used extensively by professional production companies to whom special facilities are granted and who select their music direct from the listening-rooms of the publisher concerned. Royalties are then paid to the Sound Film Music Bureau Ltd., a collecting agency acting on behalf of the publishers.

I asked Mr. Denton if it were possible for the amateur recording or cine enthusiast to enjoy these facilities without too much trouble. He said they could, provided they were members of the Institute of Amateur Cinematographers who have a special arrangement with the publishers and the Bureau to enable them to use the music at a reduced rate. Anyone interested can obtain a copy of the Institute's Schedule of Minimum Fees and other details from the Secretary, Mr. Leslie Froude, 8, West Street, Epsom, Surrey. (Tel.: Epsom 2066.)

I told him that the readers were interested in the employment of "mood" music recordings chiefly as "background" items and asked him if there were any particular definitions on this point. He drew my attention to a copy of the Sound Film Music Bureau's Schedule. It read: *Background music is music which is heard by the audience as accompaniment to the film (or recording), but is not performed by, nor supposed to be audible to any or all of the characters in the production.*

Having dealt with the subject of purchase, I then invited Mr. Denton to outline the advantages of "mood" music over that of popular music. He gave me a simple two-point answer to this question.

First, he said, copyright clearance on items of specially-composed and recorded music is a good deal easier than in the case of popular music where clearance may well be highly expensive or even impossible to obtain.

Secondly, the use of a well-known tune will, more often than not, distract an audience. Instead of concentrating on the production and accepting the music as part of the overall impression, they are tempted to give a large part of their attention to the tune to try and identify it.

"Mood" music, on the other hand, if carefully selected, can be the perfect companion to a visual or other sound impression, and when correctly laid behind the action or dialogue at the appropriate level, can complement both the picture and the spoken word. It can be used to keep a "slow" production moving, to point and underline action, and to heighten dramatic effect.

Finally, we discussed the tricky problem of selection. I suggested that, since certain types of music might conceivably lend themselves more favourably to some scenes or situations than others, an observance of this idea could greatly assist the amateur in his search for an appropriate item. Mr. Denton, however, thought differently. He agreed that most Recorded Music catalogues were listed in classified sections, but pointed out that such listings should be taken only as a very general guide. It seemed wrong, he said, to lay down hard and fast rules on the selection of "mood" music as this could only lead to unimaginative thinking.

The creative producer will steer clear of this conventional attitude and pursue a more personal and imaginative line of thought. He added that, although a certain amount of theatrical experience and a sense of dramatic illustration can be of immense help, it was not necessary to possess a large degree of technical musical know-how in order to be able to choose "mood" music items effectively, merely a reasonable appreciation of the musical content at one's disposal, and the courage to be different . . . but not *too* different!

Mr. Denton then went on to remind me of a rule governing the effective use of "mood" music which was remarkably similar to one which I, myself, laid down in my own article some weeks ago relating to *sound* effects. "Good background music," he told me, "should never be heard . . . but it should certainly be missed if it's not there!"

To assist the enthusiast without any previous knowledge of the selection of effects music, he handed me the following short summary for general guidance, together with the advice, which I duly pass on, not to take it *too* literally!

SCENIC PANORAMAS: Broad tunes with sustained strings, French horns and harp. SEASCAPES: Broad tunes featuring French horns and harp. ORIENTAL SCENES: Pizzicato strings, woodwind and xylophone. COMIC EFFECTS: Clarinets, "Wah-Wah!" trumpets, tuba and bassoon. BUSTLING TRAFFIC: Xylophones and brass. EERIE EFFECTS: Tremolo strings, vibraphone and harp.

I am sure readers join me in thanking Mr. Denton for his very helpful advice on this matter; advice which, he assures me, will be freely given to anyone who cares to write to him with their problems, or to call and see him by appointment at the Conroy Library.

The following are addresses of libraries which will supply recordings of "mood" music: *Conroy Recorded Music Library*, Berry Music Co. Ltd., 10, Denmark Street, London, W.C.2; Recorded Music Dept., *Boosey and Hawkes Ltd.*, 295, Regent Street, London, W.1; Record Dept., *Bosworth & Co. Ltd.*, 14-18, Heddon Street, Regent Street, London, W.1; Recorded Music Library, *Joseph Weinberger*, 33, Crawford Street, London W.1.



**A NEW-PRACTICAL WAY of UNDERSTANDING
RADIO · TELEVISION · ELECTRONICS**

including: Transistors; VHF/FM; Hi-Fi equipment; Computers; Servomechs; Test Instruments; Photo-electrics; Nucleonics; etc.

FOR ... Your Career ... Your Own Business ... An Absorbing Hobby

Radiostractor—an organisation specialising in electronic training systems—offers a new self-instructional method using specially designed equipment on a "do-it-yourself" basis. You learn by building actual equipment with the big kits of components which we send you. You advance by simple steps, performing a whole series of interesting and instructive experiments—with no complicated mathematics! Instructional manuals employ the latest techniques for showing the full story of electronics in a practical and interesting way—in fact, you really have fun whilst learning! Fill in coupon below, for full particulars.

POST NOW

To RADIOSTRUCTOR (Dept. G35)
READING, BERKS.

Please send brochure, without obligation, to:

Name } **BLOCK
CAPS
PLEASE**
Address }
(We do not employ representatives.)

**RADIOSTRUCTOR LEADS THE WORLD
IN ELECTRONICS TRAINING**

BINDERS

The ideal way of preserving your copies of *Tape Recording and Hi-Fi Magazine*. These new binders are designed especially to hold a year's supply of the fortnightly publication—26 copies.

No more torn covers and dog-eared edges ★ No more hunting for those mislaid copies ★ Each copy is inserted as received to form a completely bound volume for permanent reference ★ All pages open flat and effect secure binding with steel bars from first to last copy ★ Strong board binders covered with rexine with the title printed in gold on spine.



PRICE 14s. 6d.

(post free)

From: *Tape Recording Magazine*, 7 Tudor Street, London, E.C.4

HIGH QUALITY TAPE RECORDER SPECIALISTS!

BEST PART EXCHANGE

OFFICIALLY APPOINTED AGENTS FOR:

- ★ FERROGRAPH
- ★ REFLECTOGRAPH
- ★ SIMON
- ★ GRUNDIG
- ★ REPS
- ★ BRENNEL
- ★ VORTEXION
- ★ WYNDSOR

ALLOWANCE ON YOUR PRESENT TAPE RECORDER — HI-FI EQUIPMENT

MONO RECORDERS

Geloso	26 gns.
Suzzi-Mambo	39 gns.
Kurland Hi-Fi	56 gns.
Brenell 3-Star	58 gns.
*Brenell Mk. 5	64 gns.
Wyndor Victor	45 gns.
Walter 101	29 gns.
Walter De-Luxe	42 gns.
Walter 505	57 gns.
Perth Saja	45 gns.
Perth Saja De-Luxe	56 gns.
*Telefunken 75 KL-15	52 gns.
*Telefunken 85 KL	79 gns.
Grundig TK 20	52 gns.
*Grundig TK 25	62 gns.
*Grundig TK 30	72 gns.

* MICROPHONE EXTRA

Verdik	45 gns.
Specto 161	49 gns.
Specto 171	39 gns.
Veritone Venus	58 gns.
Philips	38 gns.
Philips EL 3542	59 gns.
Simon Minstrelle	39 gns.
Simon SP4	95 gns.
Saba Hi-Fi	79 gns.
*Vortexion WVA	89 gns.
*Ferrograph 4 AN	81 gns.
*Ferrograph 4 SN	88 gns.

STEREO

*Korting	68 gns.
*Harting HMB	86 gns.
*Brenell Mk.V	92 gns.

*Ferrograph 808	105 gns.
Ferrograph Stereo Add.	30 gns.

TRANSISTOR—BATTERY

Grundig Cub	26 gns.
Clarion	25 gns.
Fi-Cord	59 gns.
*Butoba	69 gns.
Minivox	37 gns.
Stuzzi-Magnette	69 gns.
Steelman	55 gns.

MICROPHONES

Reslo	
Lustraphone	
Cadenza	
T.S.L.	
A.K.G.	

Grundig	
Etc.	

- TAPES**
B.A.S.F.
Audiotape
Irish Tape
E.M.I.
Ferrograph
Grundig
PRE-RECORDED TAPES
ACCESSORIES
TUNERS
AMPLIFIERS
SPEAKERS
PICK-UPS
MOTORS

THE BEST TERMS NO INTEREST 20% deposit | 18 & 24 months terms available
12 months to pay

FREE SERVICING — FREE DELIVERY — FREE TAPE OFFERS — 150 MACHINES ON DISPLAY — OUR MAIL ORDER DEPARTMENT WILL DEAL WITH YOUR ENQUIRY BY RETURN. WRITE — PHONE — CALL FOR A QUOTATION ON YOUR MACHINE. A LARGE SELECTION OF USED TAPE RECORDERS.

REW EARLSFIELD LTD. 545 GARRATT LANE, S.W. 18 Tel.: WIM 0709
10 minutes from Tooting Broadway underground station. 100 yards from Earlsfield Station

Equipment Under Test

THE CHITNIS KM 33

By H. Burrell-Hadden

THE Chitnis KM33 is one of several domestic recording machines distributed in this country by the Chitnis company. Manufactured in Western Germany, these machines, as do the professional machines also supplied by the company, reach a very high standard in their class.

The recorder tested is a four-track machine for monophonic recording, operating at two speeds $3\frac{1}{2}$ and $1\frac{7}{8}$ ips. The maximum spool size accommodated is $5\frac{1}{4}$ inches diameter, and this means that using double play tape, a total recording time of six hours can be achieved at $3\frac{1}{2}$ ips and 12 hours at the slower speed. The rewind time is somewhat less than $2\frac{1}{2}$ minutes for a full reel of tape.

Inputs are provided for microphone at high impedance and for radio and gramophone. These are switched by three push buttons which are clearly labelled.

Three further push buttons provide for superimposition, pause control and record switching. The risk of accidental erasure is overcome, because the record button cannot be pressed down without first pushing it backwards to release the safety lock.

On record the input signal is audible on the built-in loudspeaker and this speaker can be cut off by the switch provided to prevent howl-round when using a microphone close to the instrument.

The record/replay and erase heads are fine gap types made by the German Bogen company and the fine gaps—only 0.0001375 inch—are responsible for the excellent frequency response of this machine.

The makers claim 30-16,000 cps ± 3 dB at $3\frac{1}{2}$ ips and this specification was easily met. At $1\frac{7}{8}$ ips, the makers specification of 30-10,000 cps does not quote a tolerance figure, and the machine under test gave a measured response within ± 3 dB from 40-8,000 cps and only 6dB down at 10,000 cps, a very fine performance.

These very good frequency response figures would suggest that this machine would record music very well indeed at $3\frac{1}{2}$ ips, and this was found

to be the case. Wow and flutter were negligible at this speed.

At $1\frac{7}{8}$ ips the frequency response would allow for quite good music recordings to be made but unfortunately a slight flutter is audible; indeed at this speed such a flutter would be expensive to eliminate completely in domestic equipment. Signal-to-noise ratio was excellent at $3\frac{1}{2}$ ips but at the slower speed some noise became audible.

In addition to the internal loudspeaker an output to feed a high

quality amplifier is provided, as is also an output for an extension loudspeaker.

The recorder is beautifully styled in neutral beige simulated leather, with gold anodised expanded aluminium loudspeaker grill, and is provided with a lock and key.

The total weight is less than $19\frac{1}{2}$ lb. and so this recorder can easily be carried. The equipment is sold complete with a Chitnis M50 Tr. dynamic microphone and at 62 guineas is very good value for money.

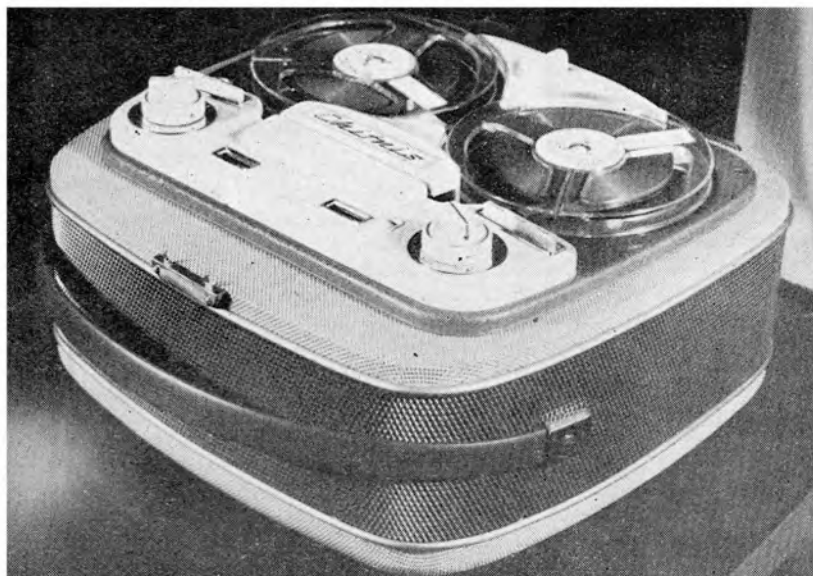

Manufacturer's Specification

Mains Voltage: 110-250 AC at 50 cps per second.

Speed: $3\frac{1}{2}$ and $1\frac{7}{8}$ ips.

Recording sense: Four Tracks-International standard (tracks 1 and 3-left to right).

Inputs: Microphone, 3mV at 2M ohms, Radio, 3mV at 100k ohms. Pick-up, 100mV at 1M ohms.

Outputs: 500mV at 100k ohms (Diode pre-amp) undistorted, 3W at 5 ohms.

Frequency Response: 30-16,000 cps at $3\frac{1}{2}$ ips ± 3 dB. 30-10,000 at $1\frac{7}{8}$ ips.

Bias Frequency: 50,000 cps.

Valves: EF86, ECC83, EC92, EM 84, EL 84 and in addition two metal rectifiers B 250/c 75, RL 32.

Consumption: app. 50 watts.

Weight: $19\frac{1}{2}$ lb.

Dimensions: $14 \times 12\frac{1}{2} \times 8$ inches.

—Signal-to-noise ratio: Better than 55 dBs (Unweighted).

Wow and flutter (combined): df. 0.12 per cent at $3\frac{1}{2}$ ips.

Fast rewinding time, less than $2\frac{1}{2}$ mins.

Price 62 gns. (including "CHITNIS M50 Tr." dynamic microphone).

AKG

microphone
helps
capture
1st prize



in National
Tape Recording
Contest

Congratulations to Mr. Pollock of Mitcham, Surrey, on winning 1st Prize in the Actuality Section of the National Tape Recording Contest, with his "Lydd Carnival Fireworks Night." Feats such as this depend greatly for the quality obtained on the microphone used. In this case, it was an AKG Model D.19 that helped Mr. Pollock to win. AKG microphones are made in a very wide range of models from popular dynamic types for tape-recorders to advanced condenser and dynamic models in use in the world's foremost TV, Broadcasting, Film and Recording Studios. Details of AKG mono and stereo microphones suitable for use with domestic tape-recorders sent on request.

AKG Dynamic Microphone D.19
Frequency range 40-16,000 c/s; Cardioid characteristic. Back to front discrimination approximately 15 dB. Diameter of head, 1 3/8 in. Available in low or high impedance. Table stand also available.

POLITECHNA

(LONDON) LTD.

3 PERCY ST., LONDON, W.1

Telephone :
LANGham 6236/8

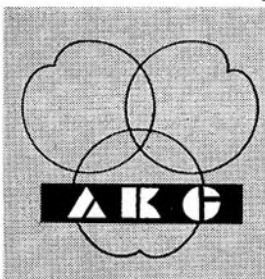

NUSOUND RECORDING CO.

Ferroglyph

(Appointed Dealer)

Tape Recorder & Hi-Fi Specialists

Showrooms: First Floor
3-8 BRIGSTOCK PARADE,
LONDON ROAD,
THORNTON HEATH, SURREY.
(Opposite Thornton Heath L.T. Bus Depot)
TELEPHONE: THO 7609

London Showroom:
35 CRAVEN STREET,
TRAFALGAR SQUARE,
LONDON, W.C.2
TEL: TRA 2080

Bib RECORDING TAPE SPLIGER

FOR EASIER AND ECONOMICAL TAPE EDITING

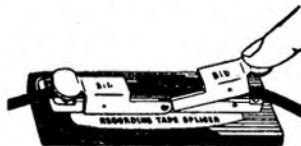

The easy-to-lift clamps on the new Mark II Bib Recording Tape Splicer are both hinged on the same side of the splicer, making the jointed tapes easy to remove. Precise, rapid tape jointing is ensured, and because you can use all the odd lengths of tape, you soon save the cost of the splicer.

Everyone who uses a tape recorder will need this little tool. It is indispensable. P. Wilson. "The Gramophone." Send a stamped addressed envelope for a helpful leaflet on tape editing.

18/6 each (subject)

If you have difficulty obtaining a Bib splicer, let us know the name and address of your dealer.

Multicore Solders Ltd., Multicore Works, Hemel Hempstead, Herts. Tel: Boxmoor 3636



MAKE YOUR
2-TRACK RECORDER

AN UP-TO-DATE
FOUR-TRACK
MONO OR STEREO

SUPER QUALITY MODEL

with a

TELEFUNKEN

4-TRACK R/R HEAD 405

Special introductory offer

Brief Specification

- Telefunken 4-track head 405-0.00014 in. gap; 50-13,000 cps; cross talk, better than 55 dB.
- With mounting instructions.

5 Gns

- Erase head to match, 2 1/2 gns.

Here is a wonderful opportunity to own a modern super-quality 4-track tape recorder without the need to buy a new machine, for an easy-to-fit guaranteed brand-new Telefunken 4-track Record/Replay Head costs you only 5 gns., with erase head to match for 2 1/2 gns. with fully detailed instructions included.

Why pay more when you can enjoy the advantages of Telefunken design and quality for such a modest outlay? Stocks are limited, so get yours now without delay. From your usual stockist, or send direct. (Cheques or P.O.s should be crossed & made payable to M.B. Audio Suppliers.)

**LIMITED STOCKS, SO
ORDER WITHOUT DELAY**

MB AUDIO SUPPLIERS 3 MIDDLETON ROAD
LONDON, N.W.11

THE WORLD OF TAPE



Popular pianist Russ Conway, currently starring in the London Palladium's "Stars in Your Eyes," seems well pleased with his new Grundig TK 35. Russ has owned a Grundig from the time they were first introduced, so his fury can easily be imagined when his flat was ransacked and his tape recorder, an earlier model, went with the rest of his possessions

Philips' invisible page boy

AS well as being a display of the most up-to-date electronic equipment in Great Britain, the Radio Show also acted as a proving ground for an ingenious gadget known as an "invisible page boy." Senior executives of Philips Electrical Ltd. carried tiny receivers clipped to their jackets and if they were required to return to the stand to answer a phone call, the receiver emitted a low-pitched whistle. Transmissions are made from a single control panel at the reception desk and 12 people can be called up individually.

The system works on the inductive loop principle, with a length of wire running completely round the centre to set up a magnetic field. Philips claim that it is the first time that such a device has been used at a Radio Show.

* * *

WHAT is claimed to be one of the largest single orders ever placed in Britain for tape recorders has just been secured by Philips Electrical Ltd.

Worth £10,000, it comprises one single-track, two twin-track and two three-track

Hi-Fi HARRY by Rich



"Good morning, Harry—it's your weekly tape from your penpal—with a P.S."

machines, all of professional type, for use in a sound and tele-film studio just completed in London. This equipment does not come under the portable description of Philips' domestic models. The three-track machine weighs about eight cwt.

TAPE RECORDING HANDBOOKS

Written by four enthusiasts, experts in their own particular field, these handy-sized guides to four aspects of tape recording should find their way into the pocket of anyone interested in hi-fi and tape recording. A MUST for the newcomer.



INTRODUCTION TO THE TAPE RECORDER

Charles Langton
3/6 (4/- inc. postage)

HI-FI FOR THE MUSIC LOVER

Edward Greenfield
3/- (3/6 inc. postage)

TAPE AND CINE

John Aldred
3/- (3/6 inc. postage)

HOW TO RECORD WEDDINGS

Paul Addinsell
3/- (3/6 inc. postage)

Available from:
Tape Recording and Hi-Fi
Magazine
7, Tudor Street, London, E.C.4



Half the fun
of owning a tape recorder
lies in discovering

the hundreds of different,
exciting things you can do with it.
This free book written for you
by twelve top stars is full of fun,
entertainment and ideas.
Read Tony Hancock on public speaking
and Joan Regan on home movies,
see what David Nixon
Eric Robinson and many other
names in show business have to say
about their tape recorders;
write today for a copy of
'TOP STARS AND GRUNDIG'.

free

**BOOK
OF
THE
MONTH**

for
tape
recorder
fans

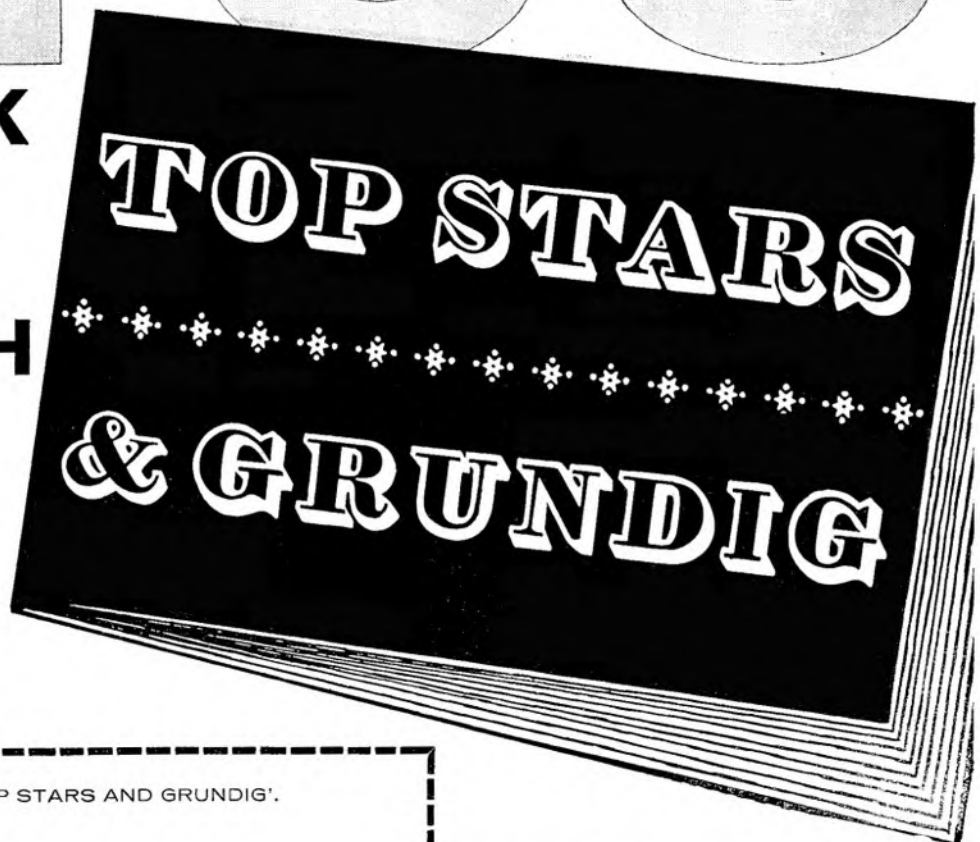

Please send me my free copy of 'TOP STARS AND GRUNDIG'.

NAME.....

ADDRESS.....

NEAREST TOWN.....

GS.TG247

GRUNDIG (GREAT BRITAIN) LTD.
Advertising & Showrooms:
39/41 New Oxford Street, London W.1.
Trade enquiries to:
Newlands Park, Sydenham, S.E.26.
(Electronics Division, Gas Purification & Chemical Co. Ltd.)

WILMEX MARKET

STEREO BALANCE UNIT

AN accurate visual indication of loud-speaker balance is provided by the Stereo Balance Unit SB1, illustrated right, now being marketed by Wilmex Ltd.

This American item will operate with any combination of stereo systems—conventional amplifiers employing a ganged volume control and balance control, or systems having separate amplifiers with independent volume controls for each channel.

Eliminating the possibility of error resulting from the normal practice of aural discrimination, the SB1 can be easily incorporated into the stereo system. Leads from the output stage of the speakers are simply connected in parallel to terminals on the back of the balance meter.

The instrument is housed in a blonde oak cabinet, and retails at £7 19s. 6d.

Another recently introduced accessory by Wilmex is the SP3 tape splicer. This embodies twin cutters enabling a pro-



fessional splice to be made in a few seconds without using scissors or a razor-blade. As little as $\frac{1}{4}$ inch of tape is used in the operation. A removable base allows the splicer to be mounted on a recorder if desired.

Wilmex Limited, 70, St. Stephen's House, Bridge Street, Westminster, S.W.1.

Cheaper "Scotch Boy" Video Tape

PRICE reductions in all lengths of No. 179 Video Tape are announced by the Minnesota Mining and Manufacturing Co. Ltd., the only company marketing commercial quantities of Video Tape.

In a recent statement, the company claims that intensive research in their laboratories has meant a continual improvement in quality; and latest production techniques have resulted in cost savings which are being passed on to Video Tape users.

A new Video Tape accessory item is also announced. It is the VRB-6 $\frac{1}{2}$ (price 29s. 9d.) pressure-moulded, high-impact plastic reel designed to hold up to 800 feet of Video Tape No. 179.

This strong, compact lightweight reel is especially suitable for spot commercials, short-test pattern recording, editing sequences and duplication.

Minnesota Mining and Manufacturing Co. Ltd., 3M House, Wigmore Street, London, W.1.

Mono/stereo plugs and sockets

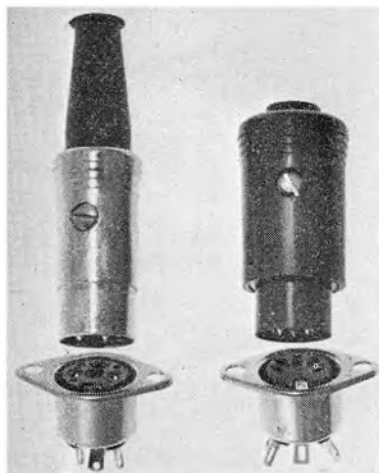

CONTINENTAL plugs and sockets, as used in many tape recorders are now being imported by Technical Suppliers Limited. These are three-pin and five-pin sockets, similar in appearance to miniature valve-holders, and their matching shielded plugs with cord sleeves.

The five-pin socket has been designed to accept both three-pin and five-pin plugs, thus allowing one socket to be used for both mono and stereo applications.

Compared with jack plugs and sockets, these types are claimed to be cheaper and neater, with superior shielding, and to allow multiple inlets and outlets from one socket.

The retail prices range from 1s. 3d. for the three-pin chassis-mounting socket to 5s. for the five-pin plug.

Technical Suppliers Limited, 63, Goldhawk Road, London, W.2.

New Products

Dual role tape splicer

A NEW tape splicer, recently introduced by Metro-Sound Manufacturing Co. Ltd., is the first of its kind suitable for use with either magnetic recording tape or 8 mm. cine film.

The dual role of the new splicer is provided by means of an interchangeable positioning channel. When used with cine film the normal quarter-inch locating groove for tape is replaced by a level-topped channel along one edge of which are two small locating pegs for the film sprocket holes.

A transparent top in the cutting cartridge shows exactly where the cut is made, and the blade itself can revolve in a 45 degree arc for an "acute" tape cut, or a "vertical" film join. A spare blade and film emulsion removal scraper is supplied with the splicer.

Spring loaded clips hold the tape or film in position, and calibrations, in inches and millimetres, are marked along the top of the unit, and two countersunk fixing holes enable it to be screwed on to tape decks.

A comprehensive instruction sheet is supplied with the high tensile nylon moulded splicer which will retail at 15 shillings.

Metro-Sound Manufacturing Co., Ltd., 19a, Buckingham Road, London, N.1.

NAME CHANGE

THE name of the company marketing Ampex precision magnetic tape recording equipment in the United Kingdom has been changed from Redwood City Engineering, Ltd., to Ampex Great Britain Limited. The offices of the renamed firm, a subsidiary of Ampex International S.A., Fribourg, Switzerland, are adjacent to those of Ampex Electronics, Ltd., the parent company's British manufacturing subsidiary, at Reading, Berks.

Price reductions

ALTERATIONS in the tariff duty and increased production of the Stuzzi recorders have enabled the manufacturers to reduce their prices. As from August 1, the Tricorder will retail at 63 guineas, and the Magnette at 59 guineas. Both prices including microphone and reel of tape.

Recording Devices Limited, 44, Southern Row, Kensington, London, W.10.

NOW ON SALE

*The fullest, most authoritative and
most up-to-date survey of stereo*

THE SUMMER 1960 ISSUE OF

Stereo **Sound and
music** **magazine**

CONTENTS INCLUDE

The Stereo Disc—The Invention and its Development

The Clarinet in Stereo

Saving Space with a Speaker System

Stereophony and the B.B.C.

New Stereo Products

A Distinguished Critic Discusses Rachmaninov Stereo Issues

Microphone Methods for Stereo

Classical, Jazz, Light Orchestral, and Theatrical
Record Review

GET YOUR COPY NOW—BEFORE IT SELLS OUT

2s. 6d.

*If in any difficulty order direct from the publishers,
Print and Press Services Ltd., 7 Tudor Street, London, E.C.4*

News from the Clubs

Edited by

FRED CHANDLER

SURPRISE of the year, which should provide food for thought amongst the long-established clubs, and some guidance on the "activity versus administration" war for the newly forming clubs, is the news that the Club Section for the 1960 British Amateur Tape Recording Contest was won by a group of enthusiasts who do not come within the general idea of a tape club.

The winning tape, *Ban the Phon*, was produced by Messrs. G. J. Garrett, R. A. S. Gouldsworthy and P. Tucker, three nineteen-year-old enthusiasts, who have only been recording for fourteen months.

Their tape, a good-natured satire on the nuclear disarmament campaigns, was produced using two Gramdeck tape tables, and pre-amplifiers, worked in conjunction with turntables manufactured by Collaro Ltd. and Chancery Precision Instruments Ltd.

Other equipment used included two Lustraphone LD/61 moving-coil microphones, and two R.S.C. (Leeds) Ltd. A.7 amplifiers. Two volume controls, a tape splicer, and an extension piece to hold the second tape table for an echo effect were built by the three producers.

The initial announcement on the tape that the phon, a measurement of sound, should be banned, is followed by reports in the Press and by the BBC of the instigator's activities.

"In order to avoid copyright difficulties, the 'BBC pips' were reproduced by a 50 cycle AC mains hum in a loud-speaker, speeded up to 960 cycles, because no sine wave generator was available," said Mr. Garrett, giving an example of the painstaking care given to the production.

Sound effects for the "demonstration" at Westminster were obtained from a bus shelter on the Thames Embankment using "an ancient clockwork gramophone" and a Gramdeck, with a parabolic reflector on the microphone.

A fine effort, and worthy of the first prize. The tape was a close second to the *Tape of the Year*. The judges' award was endorsed by the applause which followed the end of the tape during playback at Earls Court on August 27.

I like particularly the attitude taken by Peter Holloway, Secretary of the **West Herts** club. His club's failure to win a prize in the Contest provided their first disappointment since their inauguration.

Writing in his monthly report, he said: "One thing is certain, the standards must be extremely high—a good thing for us all.

"The winning club is to be congratulated, for we had done considerable work on our entry, and now realise just how much time can be spent on producing just fifteen minutes of actual programme material. We have gained a tremendous amount of experience and will enter next year's contest with greater confidence."

Although the total number of tapes entered by clubs in this year's Contest was up on last year, the percentage was again disappointing.

In an effort to give as much time as possible to prepare entries, I would like to hear from club members what subject should be set for next year's Contest, or should we keep the Club Section open as it was this year.

Some clubs have intimated this would be best, but I would like YOUR club's opinion before deciding.

Every club should have had a chance to meet and discuss this point by November 1, so to give as much preparation time for 1961 as possible we will set that day as a closing date for suggestions.

A decision that meetings would be held fortnightly in future was made at the August 18 meeting of the **Harrow** club. At the meeting held, for the first time, in the newly acquired club rooms at St. George's Hall, fifteen persons attended, joined the club, and proceeded to elect officials. Mr. Ken Peters was elected Chairman, Mrs. Toni Fisher, Secretary, and Don Fisher, Treasurer. Their next meeting is on September 14.

Another newly-found meeting place, as reported in our last issue, is that of the **Acton and West London** club. At the first meeting, on August 19, the main item was a demonstration of Acos microphones.

Following a general introductory talk on microphones, Mr. Wells and his three assistants from Cosmocord Ltd. proceeded to demonstrate a few of their products. The Stereo 44 created a great impression on members, tapes being played on the Brenell 3-Star, with two Lannoy Chatsworth speakers.

The club then split into groups, with an Acos man at the centre of each.

Also present at the meeting was Freddie Westcott, the new Chairman of the Federation, and a visitor from Rhodesia who arrived with his Telefunken 76 K. Both were impressed by the club and future visits have been arranged.

The meeting closed with arrangements being made for a group visit to the Radio Show. Their next meeting will be on September 7, when a demonstration of pre-recorded stereo tapes and a talk on the history of tape will be given to a local society.

The **Ware** club is arranging to record a series of humorous plays soon to be produced by the local dramatic society. The recordings will be made available to the old and infirm in the area.

The plays will also be offered to the surrounding hospitals.

This was decided at the club's August 15 meeting, when a proposal that members should take part in the Youth Carnival on September 10 was also made.

The remainder of the evening, following detailed discussion on these two points, was devoted to the playback of members' favourite recordings, and a demonstration of the Garrard magazine tape deck by Mr. Saul.

A demonstration of the Grundig range of recorders, including the Cub and the new four-track TK 24, will be given at their next meeting on September 12 at "The Old Brewery Tap," in the High Street.

Thirty-seven members attended the July 21 meeting of the **Coventry** club, maintaining the average attendance for the summer season.

In keeping with the time of year, the meeting took on the less serious aspect of tape recording. Items were varied and included Roy Penfold's presentation of the vexed question "The Law of Copyright" followed by "Best ways to record from the radio" (?).

(Continued on page 41)

Members of the **Ilford** Club group round a **Fi-Cord** portable recorder during a demonstration by Chairman Percival Ager, seen on the front left of our photograph



Classified advertisements

Rate—Sixpence per word (minimum 5s.); Trade, ninepence per word (minimum 10s.); box numbers, one shilling extra. Payment with copy. Copy should be sent to Advertisement Department, "Tape Recording Fortnightly," 1, Crane Court, Fleet Street, London, E.C.4.

FOR SALE. Vortexion WV8 just overhauled, £70. Ferrograph 3AN £45. Both together £100. Smith, 89, Esmond Road, London, W.4.

PRE-RECORDED TAPES all makes, 7½ and 3½ ips., send for free lists or visit TELETAPE (Dept. TR6), 33 Edgware Road, W.2. PAD: 1942.

WB. HF 816 3-7. 5-15 Ohms, 8 in. MC speaker. Used once. List £6 10s. 6d. Bargain £4 10s. Will exchange ribbon mike, etc. Mr. M. J. Norton, Kingcott Mill Farm, Flax Bourton, Bristol.

GRUNDIG sales/service in your area: High Wycombe phone 457, Newbury phone Thatcham 3327, Wallingford phone 3083, Orpington Kent, phone Orpington 23816, New Malden phone Malden 6448, Watford phone Garston 3367.

FERROGRAPH 4AN 5 months old, absolutely perfect. Manufacturer's Guarantee, many extras. Reslo microphone, spare tapes. Originally £100. All 75 gns. o.n.o. Box 383, *Tape Recording & Hi-Fi Magazine*, 1, Crane Court, London, E.C.4.

Clarion battery recorder. Radio lead, extension lead, 500 ft. tape. Perfect (cost £30) £20. Browning, 82, Cromwell Road, Rugby, Warwickshire.

Grundig TK35 for sale. Good condition. Complete with microphone. £65 or near offer. Write or phone, Tel.: Bromham 312. H. G. Potter, Horse Lane Farm, Rowde, Devizes, Wilts.

FRIENDLY FOLK ASSOCIATION, 87, Terrace, Torquay. Leading International Correspondence Hobby Club since 1943. Now included, facilities for Tapesponding Details free.

Collector urgently requires 78's by any Hawaiian groups, especially Owens, Kinney, Mendelssohn, McIntire, Peachey, Iona. Send your disposal list to 4188642 L.A.C. Burchell, L., A.S.F., R.A.F. Marham, Nr. Kings Lynn, Norfolk.

VERDIK 45-gn. model Recorder, 7½, 3½ips., separate playback head, instant monitoring, new, 35 gns. Iskip, 42, Chesterton Road, Cambridge.

Shop-soiled Clarion Transitape battery operated transistorised Tape Recorder. Bargain, for quick sale £18. Ford, 3 Aller Park Road, Newton Abbot.

For Sale. Elizabethan tape recorder £24 (cost 45 gns.). Box 384 *Tape Recording & Hi-Fi Magazine*, 1, Crane Court, London, E.C.4.

TAPE RECORDING, March 1957 to December 1959, complete 36 copies in all. £2 10s. o.n.o. M. A. Fennell, 11 Roseland Avenue, Devizes, Wilts.

New, unused in original makers carton, one pair 1960 Truvox "Stethoset" headphones, Model TA2000. List 3 gns., accept £2. Post free. Mr. C. Leyden, 2 Garnett Villas, Otley, Yorks.

Elizabethan Essex recorder, cost £71, 6 watts quality output, mixing of inputs, etc., three speed. Collaro deck tape. New, bargain £40. D. F. Saunders, 177 Ford Lane, Rainham, Essex.

WANTED. High quality LOUD-SPEAKER, Goodman Axiom 300 or Wharfedale. Pre-recorded tapes, classical. Gram turntable. J. H. Parry, Denmark Court Hotel, Denmark Road, Exeter, Devon.

Recording Tape. Save up to 30 per cent. Send for list. Also 50 secondhand Recorders in stock. E. C. Kingsley & Co., 132, Tottenham Court Road, London, W.1. EUS 6500.

Bargain parcel. Splicing Tape with Splicer, Tape Calculator, four different colour marker tapes, twelve hundred feet branded recording tape (new). Money back guarantee. Send £1 10s. now. Watford Supplies, 81, Queen's Road, Watford, London.

Tape to Disc—All Speeds Rendezvous Records, 19, Blackfriars Street, Manchester 3. Leaflet on request.

Telefunken KL 85 with D11B microphone, in and output leads etc. Cost £90. Mint condition. 65 gns. 252, Broad Road, Bocking, Braintree, Essex. Phone Braintree 265.

Tape recorder need repairing? Then let London's Largest Tape Recorder Specialists do it for you, expertly and economically. Essex Tape Recorder Centre, 2, Maryland Point Station, Stratford, E.15.

FERROGRAPH 4 A/N's-808's, VORTEXION WVA, WV8, SIMON SP4, REFLECTOGRAPH A-B, etc., always in stock and ready for immediate delivery, as well as over 200 latest 1960 recorders at London's Largest Tape Recorder Specialists. The best, lowest H.P. terms, and finest selection of new and s/h recorders, from £18. Generous P/E allowances. Essex Tape Recorder Centres, 2, Maryland Point Station, Stratford, E.15, and 205, High Street North, East Ham, E.6.

JOHN HASSELL RECORDINGS. Tape/Discs. All Speeds. CCIR Studio, 21, Nassau Road, London, S.W.13. Riverside 7150.

FOR SALE. Telefunken 85 KL Recorder, 2 months old. Cost 82 gns., accept £58. Phone Euston 2052 before 9 a.m.

E.S.T.R.A. The English Speaking Tape Respondents' Association is a new club founded to promote tape friendship. Membership world-wide. Details from Honorary Secretary, Robert Ellis, Whitsome, By Duns, Berwickshire, Scotland.

Price Reduced

TAPE TIME CALCULATOR

The *Tape Recording and Hi-Fi Magazine* accessory, giving playing times for any size reel or length of tape is now available again—and at a reduced price.

Repeated requests for this simple, read-at-a-glance device for any speed from ⅜ths to 15ips, have led us to reprint and orders can now be accepted at the address given below.

Price 216d

(3/- including postage)

Order from:

**Tape Recording Magazine,
7, Tudor St., London, E.C.4**

TALKING OF "SOUND"

3 p.m. Sunday, September 18th

(with a repeat on Monday, September 26th, at 6.40 p.m.)

A preview of the new series of programmes for radio and recording enthusiasts introduced by John Kirby

Before we begin . . .

R. D. Brown, Editor of "Tape Recording Fortnightly," John Borwick, Assistant Editor of "Hi-Fi News," and Donald Aldous, Technical Editor of "Gramophone Record Review," are joined by a listener to discuss "Sound" and its place in the magazine world.

Produced by Marguerite Cutforth

"Sound" begins its series on October 2nd, at 2.40 p.m.

News from the Clubs

(Continued from page 39)

To follow was a less serious subject by Mr. Hopkins, who presented a monologue entitled "Commandments of Conscriptio"—a study of army life. Peter Warden played a recording of an interview given in America by the two British Sergeants who spent their leave racing across the United States.

For the first time on record, it appeared that members were going to run out of tape before the meeting closed. However, those two stalwarts, Howard Freer and Tom Bagley, again came to the rescue and played two tapes of humorous anecdotes.

Members' tapes again took up most of the following meeting, on August 18. Roy Reynolds had promised another of his light-hearted tapes, this time on the parking problem, and Henry Hopfinger had gathered material for a talk on civic affairs. If the floor area permitted, he was also prepared to give an illustrated lecture on the art of recording weddings, promising to take along samples of layout as used in three different churches.

Roy Penfold, club chairman, was away on holiday at the time, but present in spirit, he promised to post some recordings for playback at the meeting, from Bournemouth.

The West Herts club members have introduced the ever-popular club activity, demonstrations of personal recorders. At Watford on July 27, John Grainger took along his Simon SP/4 and gave members a detailed look at the facilities available on this superb instrument.

A pre-amplifier which John had recently built was also put through its paces when members took part in a three-microphone mixing experiment on the SP/4.

About a month previous to the meeting, each member had been set an editing problem in the form of a tape containing a jumbled recording. At this meeting Miss Heather MacRae judged the returned entries and awarded most points to Peter Holloway who produced the nearest solution to the correct sequence of sounds.

The meeting concluded with general activity, some members producing sound effects, and others taking a closer look at the Grundig Cub portable recorder. This instrument was demonstrated by Jean Stern who also presented a tape recorded on the Cub at London Airport when David Whitfield returned from his Australian tour.

At the August 10 meeting at Hemel Hempstead Sid Attwood demonstrated the Ferrograph 4A/N. A mysterious piece of string attached to the machine had members guessing until it was revealed as the "Attwood" pause control—so simple, yet so effective.

Jack Hill and Peter Walmsley had been busy prior to the meeting producing sound effects and background music for a short thriller play. Casting for the play was carried out and members straightaway proceeded to record a performance.

Errors of timing and microphone technique on the unsatisfactory first recording were improved upon during the second attempt, and a great deal of valuable experience was gained for future productions.

An extension of programmes for the hospital and blind services was agreed upon and Arthur Mitchell was elected as programme secretary responsible for organising this part of the club's activities.

Another club recently formed is that in **Brixton**. On August 10 the formation of a committee started the proceedings,

followed by the normal practice of outlining club rules, laws and subscriptions.

This done, members settled down to a lecture demonstration on frequency response by the club's founder, Mr. L. J. Walker. A Philips 3538 recorder and a Dulci DPA 10 pre-amp and amplifier were used to illustrate the talk.

No wasting time in this club, the members followed up this lecture with further facts about recording at their second meeting on August 24 when the subject was modulation on tape.

A variety of items also at the August 11 meeting of the **Rugby** club.

The meeting started with the playback of a request tape from Fred Gazeley, Secretary of the Sightless Members' Section of **The Voicеспondence Club**. After this came the usual quiz tape presented by Mr. Cotgrove. This was won by Mr. R. Goodman. An example of the "noises" produced in his tape was afterwards produced by Mr. Cotgrove. This turned out to be a mechanical toy picnic bear which was immediately greeted with affectionate cries from the sentimental members.

Settling down to pure tape, the chairman, Mr. Bannister, introduced the main speakers for the evening, Mr. A. W. Dakin and Mr. A. Lowe of Nottingham Tape Recorders Ltd.

These two gentlemen had brought along a Ferrograph recorder, cabinet speaker and a Stuzzi portable and proceeded to give demonstrations of their capabilities.

After a talk covering the important points of recording—specifications and their use as a guide to buying a recorder, Mr. Dakin played part of the very first recording ever made (in 1912 by HMV) before the introduction of microphones and valves. A 1928 recording by Decca followed—we now had valves and a few carbon microphones around—then a jump to 1932 and finally to 1953 and the first pre-recorded tapes in this country. This in turn was followed by two contrasting tapes of "Saturday Night at the Nottingham Palais."

Fred Gazeley's request tape also found its way to the **West Middlesex** club where members are now searching for ways to help him and his worthwhile cause.

Discussion at the August 25 meeting centred around this problem, when the whole aspect of the argument brought up at the Federation Congress in July was thrashed out.

In his recent report, Secretary H. E. Saunders wrote that it cannot be denied there is a strong argument for saying a tape club does not exist primarily as a welfare organisation, but for the creation of what may possibly be considered as an art form. If this be the case, then perhaps such works should best be left to the individuals of a club and not form part of the normal activities of the club proper.

Whatever was decided at the August 25 meeting, I have not heard at the time of writing; there is, as Mr. Saunders says, a good argument on this point.

There is no doubt, judging from the letters received, that the majority of clubs now being formed need the guidance of the older clubs in matters such as these, and I would like to remind club members that we welcome letters to advise new clubs, create talking points, or indeed just let off steam.

CLUB MEETING DIARY

ACTON: Every Friday at The King's Head, Acton High Street.

BIRMINGHAM: Every Monday at the White Horse Cellars, Constitution Hill.

BLACKPOOL: Every Wednesday at 173, Church Street.

BOURNEMOUTH: Alternate Tuesdays at the Civil Defence Centre, Holdenhurst Road (Next: Sept. 20).

BRIGHTON: Every Tuesday at Fairlight School, Pevensey Road.

CATFORD: Every Friday at St. Mary's C.E. School, Lewisham, S.E.13.

CHESTERFIELD: Every 3rd Monday at the Yellow Lion Inn, Saltergate. (Sept. 13.)

COVENTRY: Alternate Thursdays at Rotherham's Social Club. (Sept. 15.)

CRAWLEY: 1st and 3rd Mondays in month at Southgate Community Centre.

EDINBURGH: 1st Tuesday and 3rd Sunday at 23, Fettes Row, Edinburgh 3.

GRIMSBY: Alternate Tuesdays at the RAFA Club, Abbey Drive West, Abbey Road. (Sept. 13.)

GRANTHAM: Weekly. 1st week in month, Wednesday; 2nd, Monday; 3rd, Thursday; 4th, Friday, at Grantham Technical College, Avenue Road.

HARROW: Alternate Thursdays at St. George's Hall, Pinner View, North Harrow. (Sept. 15.)

HUDDERSFIELD: Fortnightly, alternate Thursdays and Fridays at the Congregational Church Schoolroom, Great Northern Street. (Sept. 8.)

ILFORD: Every Tuesday at the RAFA Rooms, Cranbrook Road.

IPSWICH: Fortnightly, alternating Fridays and Saturdays at the Art Gallery Committee Rooms (Sept. 10) and The Kings Arms Hotel, Cornhill (Sept. 16).

KEIGHLEY: Alternate Wednesdays at the South Street Sunday School Rooms. (Sept. 21.)

KETTERING: Alternate Wednesdays at the Rising Sun, Silver Street. (Sept. 14.)

LEEDS: Every Thursday at the British Legion Club, Albion Street, Leeds 1.

LEICESTER: 2nd and 4th Friday at Bishop Street Reference Library.

LONDON: 2nd Thursday at the Abbey Community Centre, Marsham Street, S.W.1.

LUTON: 2nd and 4th Tuesdays at 17, Dunstable Road.

MANCHESTER: Every Saturday, 6 p.m., at 20, Naylor Street, Hulme, Manchester 15.

MIDDLESBOROUGH: Every Tuesday at 130, Newport Road.

NOTTINGHAM: Alternate Thursdays at the Co-operative Educational Centre, Broad Street. (Sept. 15.)

RUGBY: Alternate Thursdays at the Red Lion, Sheep Street. (Sept. 8.)

STAFFORD: Alternate Tuesdays at The Grapes, Bridge Street. (Sept. 13.)

STOKE NEWINGTON: Every Wednesday at 53, Londesborough Road, N.16.

WALTHAMSTOW: Alternate Fridays at 26, Church Hill, E.17. (Sept. 9.)

WARWICK: Alternate Wednesdays in Room 18 of the Royal Leamington Spa Town Hall. (Sept. 21.)

WEST MIDDLESEX: 2nd Thursday at the Railway Hotel, Station Road, Hampton, and 4th Thursday at St. George's Hall, Lancaster Road, Southall Broadway.

WEST WALES: 1st and 3rd Thursdays at The Meeting House, New Street, Aberystwyth.

WEYMOUTH: Alternate Wednesdays at the Waverley Hotel, Abbotisbury Road. (Sept. 21.)

WINDSOR: Every Thursday at the Royal Adelaide Hotel.

WINCHESTER: Every Friday at The Ship Inn.

YORK: Every Thursday at 25, Broadway Grove, York.

Unless otherwise stated, meetings start between 7 and 8 p.m.

Is your club included in this list? If not, send details on a postcard, including date of next meeting. The list will appear in future as space permits.



YOUR LOCAL DEALER

In this feature you can check your nearest dealer who is a hi-fi specialist giving expert attention to tape equipment.

LONDON

Lee Electronics

TAPE RECORDER & HI-FI AUDIO SPECIALISTS
400, EDGWARE ROAD, LONDON, W.2

London's leading Stockists of High-Fidelity and Audio Equipment. Many Bargains in new and reconditioned Equipment.

SEND FOR FREE LISTS

All Machines demonstrated for performance on Record and Playback. All leading makes of Hi-Fi equipment from stock

PADDINGTON 5521

SHEEN

TAPE RECORDER CENTRE LTD.

Specialists in Tape Recorders and accessories serving London and Home Counties.

—THE CENTRE FOR—

FRIENDLY HELP—SALES—SERVICE
HOME DEMONSTRATIONS, DAY OR
EVENING TO SHOW ANY MODEL
YOU REQUIRE—ADVICE ON ALL
—MAKES FROM 19 GNS.

CALL—WRITE—PHONE

8 Station Parade, Sheen Lane, Sheen,
London S.W.14 (next to Mortlake Stn., S.R.)
Showrooms: PROSPECT 0985 10 a.m.—7 p.m.

NORTH-WEST

SHINNS' of LEIGH LANCASHIRE

ARE RECORDER EXPERTS
(22 years in disc 12 in tape)

IF YOU HAVE A SERVICING PROBLEM
CONSULT US!

40 different models always in stock
H.P. terms to suit you—part exchanges

WE ARE EXHIBITING AT THE
NORTHERN CLUB TRADE FAIR
(STAND 10)

NORBRECK HYDRO, BLACKPOOL
SEPTEMBER 12-16th

SHINNS' LTD. Town Centre, Leigh, Lancs.

THE SOUTH

There is always something extra when you buy a TAPE RECORDER from

THE HIGH-FIDELITY CENTRE
TAPE RECORDERS — HI-FI SPECIALISTS
— RECORDS

LARGEST STOCKISTS

Recorder Hire Service

SEND FOR OUR BARGAIN LISTS OF
NEW AND SECONDHAND EQUIP-
MENT.

EQUIPMENT BUILT TO ORDER. Dorking 4229
61 WEST STREET, DORKING, SURREY

ALL TAPE RECORDERS From the Specialists

TAPE RECORDERS

(Bournemouth) LTD.

Main Area Dealers for

FI-CORD : PHILIPS : GRUNDIG

Authorised Service Agents for

TELEFUNKEN & WALTER

(Southern England)

Tapes and Accessories by Return. Terms available
on New or Reconditioned sets.

WRITE OR PHONE FOR FREE
BROCHURE

Seamoor Road, Westbourne,
BOURNEMOUTH, Hants.
Telephone: Westbourne 64292

Index to Advertisers

	page
Audio Devices Ltd.	9
British Ferrograph Recorder Co. Ltd.	3
Cosmocord Ltd.	8
Deroy Sound Service	42
Elizabethan (Tape Recorders) Ltd.	Front Cover
E.M.I. Sales and Service Ltd.	2
F. A. Hughes & Co. Ltd.	44
Fi-Cord Ltd.	16
Gopalco Ltd.	43
Gramdeck	32
Grundig (Great Britain) Ltd.	36
High Fidelity Centre	42
Howard Tape Recorders	43
Lee Electronics	42
Lustraphone	6
Magnegraph	42
M.B. Audio Suppliers	34
Metro-Sound Manufacturing Co. Ltd.	43
M.S.S. Recording Co. Ltd.	6
Multicore Solders Ltd.	34
Nusound Recordings	34
Perth Radios Ltd.	7
Politechna Ltd.	34
Radiostructor	30
Rapid Recording Service	42
R.B. Tapes Co. Ltd.	10
Reps (Tape Recorders) Ltd.	10
R.E.W. Earlsfield Ltd.	30
Sheen Tape Recorder Centre Ltd.	42
Shinns Ltd.	42
Sunderland Sound Services	42
Tape Recorders (Bournemouth) Ltd.	42
The Tape Recorder Centre Ltd.	4 & 5
Welmecc Corporation Ltd.	24

TAPE TO DISC SERVICES

SSS Private gramophone record made from your own tape

Microgroove LPs from 20/6
Standard 78s from 10/6

Mobile Unit available for Weddings, Receptions,
Choirs, Meetings, etc. S.A.E. for full details:—
John Levis, Sunderland Sound Services,
28, Viewforth Terrace, Sunderland 57032
▪ If you can hear it — We can record it! ▪

RAPID

Recording Service

78's and L.P.'s from your own tapes.

Master Discs and Pressings.

Recording Studio
equipped with Bechstein Grand.

Practising studios
with or without accompanist.

Mobile Recording Van.

"Off the Air" Service.

21, Bishops Close, Walthamstow, E.17. COP 3889

When writing to manufacturers for information about new products, please mention that you saw it in "Tape Recording and Hi-Fi Magazine."

TAPE RECORDER HIRE

TAPE TO DISC 78-LP
RECORDING STUDIO
SALES—EXCHANGES

MAGNEGRAPH

1, Hanway Place, London, W.1.

s.a.e. for leaflet or
telephone: LAN 2156

TAPE TO DISC RECORDING

Microgroove LP from 27/6d.

78 rpm from 11/-

Also 45 rpm

48 HOUR SERVICE

S.A.E. for comprehensive leaflet to:—
Marsh, "Deroy" Sound Service, Little
Place, Moss Delph Lane, Aughton, Orms-
kirk, Lancashire. Tel.: AUG 3102



ALL YOUR RECORDINGS CAN BE FOUND QUICKLY AND EASILY BY USING —

METRO-TABS

3/11 per set

A new and scientific device designed to clean the Record and Erase heads of your tape recorder, and to reduce faults caused by oxide deposits. Price 12/6



Write for illustrated leaflets to:

METRO-SOUND MFG. CO., LTD.

19a BUCKINGHAM ROAD
LONDON - N.1
Telephone: CLIssold 8506/7

THE NAME TO REMEMBER IN TAPE HEADS IS

BOGEN

ACCEPTED AS THE WORLD'S BEST FOR 4-TRACK STEREO AND MONO TAPE RECORDERS

- Frequency response 30—16,000 c/s at 3½ i.p.s.
- Gap—3.5 microns (0.0001375 in.) per channel ground and lapped.
- Magnets—special laminated steel.
- Working life—10,000 working hours; about 10 years' normal use.
- Screening—full mu-metal, with colour coded leads.
- Price—set comprising 4-track record/replay head and erase head—15 gns.
- Bogen heads are easily fitted. They are characterised by the same standards of manufacture as Bogen heads costing over £100 each.

*It's better to convert to 4-Track with genuine **BOGEN***

HEADS

Full details on request from the sole distributors for U.K. and British Commonwealth

Gopalco Ltd. 1 LONG ACRE, LONDON, W.C.2
COVent Garden 2052

FREE H.P.!

WE HAVE THE BIGGEST SALES IN GT. BRITAIN
WHY? BECAUSE WE GUARANTEE YOU
THE BEST TERMS!

- ★ No interest charges
- ★ 2 years to pay
- ★ Deposits from 10%
- ★ Any machine



SPECIAL DISCOUNTS ★ FREE SERVICING—NO CHARGES ★ BUY FROM US—THE LARGEST MAIL ORDER DEALERS, WHEREVER YOU LIVE ★ FREE DELIVERY ANYWHERE IN U.K. ★ NO PURCHASE TAX

400 machines, 80 different new and secondhand models on permanent demonstration in our showrooms ★ Open all day Saturday
★ All accessories in stock or sent by Mail Order ★ Main Agents for all the best makes ★ Our Mail Order department specialises in orders by post with thousands of sales throughout England, Wales, Scotland & N. Ireland ★ Excellent commission paid on any sales you make for us

WRITE, PHONE OR CALL NOW FOR FREE BROCHURES AND FULL DETAILS OF OUR TERMS:

HOWARD
PHOTOGRAPHIC

218 HIGH ST. BROMLEY. KENT. RAV 4477

In recording circles throughout the world, enthusiasts vie with each other to get the most natural sound from tape. Authenticity is however most important when tape recording is the tool of scientific research. Anthropologists

Authentic Sound goes round the world



in Africa thus require a recording tape that not only captures the fleeting sound of tribal song for leisure study, but also retains it despite the destructive effect of sun and sand. BASF Magnetic Recording Tape is made to do just this. It has a base of Luvitherm, the tough, flexible plastic which permanently holds magnetic oxide in the tightest bond; and the oxide itself is made by a special BASF process to ensure magnetic stability no matter how long the tape is stored. This outstanding tape can be used in all climates for every type of recording. BASF is the original recording tape. A vast reserve of more than 25 years experience and continued development keeps it ahead for authenticity. On BASF tape you can always be sure of registering your recorder's complete range of frequencies...always reproducing them... always obtaining Authentic Sound whatever and wherever you record.

Insist on
the tape with
the Luvitherm base



Magnetic Recording Tape

Standard • Long Play
Double Play • Editing Sound

F. A. HUGHES & CO LTD 4 STANHOPE GATE LONDON W1

**REDUCING
WOW AND
FLUTTER** pages
20-21

TAPE

**RECORDING
FORTNIGHTLY**

**NO
INTEREST
CHARGES**

all makes of TAPE RECORDERS and HI-FI EQUIPMENT
BEST HP TERMS AVAILABLE ANYWHERE TODAY

NO INTEREST CHARGES up to 18 months on the exclusive Tape Recorder Centre Low-Interest Two-year plan

plus THE MOST COMPREHENSIVE STOCKS OF ALL MAKES
Plus **UNIQUE FREE 72-PAGE CATALOGUE**

listing hundreds of Tape Recorders, Accessories and Hi-Fi Equipments

CHOOSE IN PERSON — CHOOSE BY POST

Call at the Showrooms — Central London:
82 High Holborn, W.C.1. CHA 7401
North London: 75 Grand Parade, Green Lanes,
Harringay, N.4. STAmford Hill 1146

or write or phone for the sensational FREE
catalogue: TAPE RECORDER CENTRE Ltd.
Dept. TF, 75 Grand Parade, London, N.4.
STAmford Hill 1146



**THE TAPE
RECORDER
CENTRE**

FIRST AND FOREMOST IN THIS FIELD

ALTERNATE
WEDNESDAYS **1/6**
21st September, 1960

BRITISH AMATEUR TAPE RECORDING CONTEST, 1960

FIRST PRIZE

*in the Clubs Section
awarded to tape
recorded with*

GRAMDECK

GRAMDECK is something completely new and revolutionary in tape recorders. It is an ingenious invention that turns your gramophone into a tape recorder and back into a gramophone at will!

Slip the Gramdeck onto your turntable and you have the finest tape recorder you have ever heard. Lift it off and your gramophone is ready to play records again, so that you have the pleasure of tape or disc recordings at your finger-tips—in ONE instrument.

(who offer their heartiest congratulations to Mr. D. J. Garrett and his associates).

Records at 7½ i.p.s. (with gram. set at 78 r.p.m.) or three other speeds. Manual and motor re-wind. Automatic erase. Printed-circuit. Transistorised Control Unit. Pre-Amp. Facilities for superimposing. Records outdoors on clockwork turntable. Fully guaranteed and first-class after-sales service.

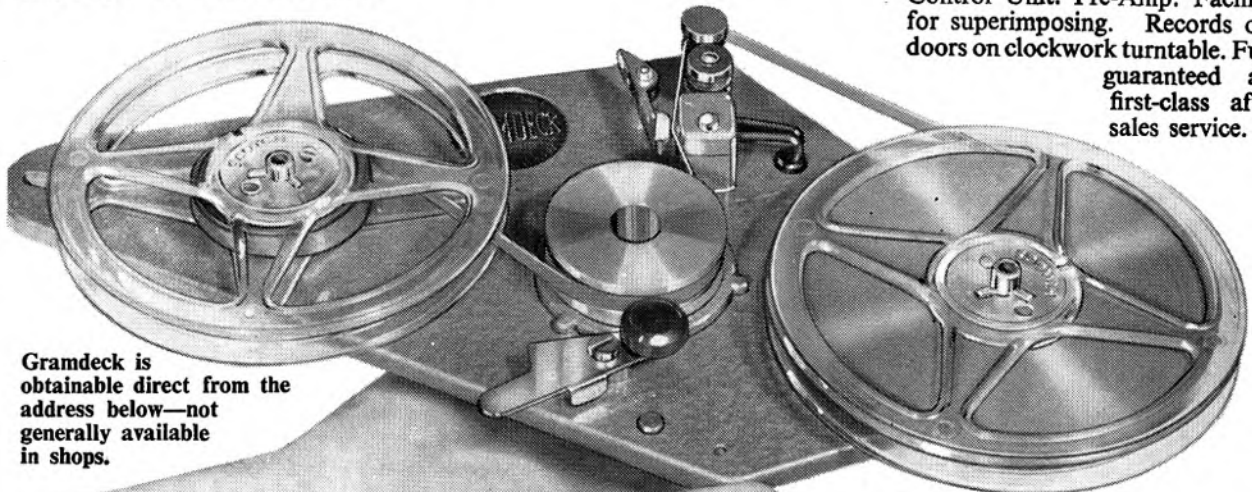

Gramdeck is obtainable direct from the address below—not generally available in shops.

An expert, writing a Test Report in *The Gramophone Record Review*, said:—

“I have had one of these units under test for several months . . . I have nothing but praise for it . . . this very inexpensive mechanism can be thoroughly commended.”

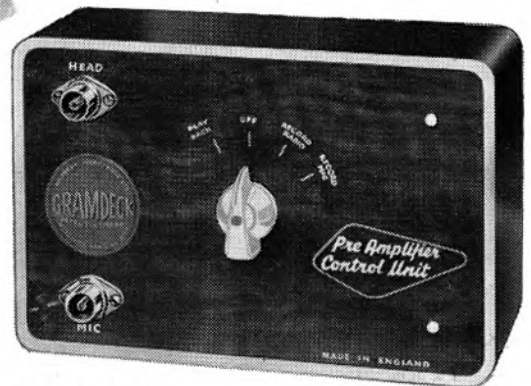

and Gramdeck now costs even less!

only

11 GUINEAS

Complete with Control Unit/Pre-Amp. and 600' Tape

(Special Moving Coil Microphone Extra)
YOURS FOR 13/- DOWN and 18 fortnightly sums of 13/-

Free!



SEND FOR

FULLY ILLUSTRATED FREE BOOK!

Technical information, photographs, test reports . . . everything you want to know about the amazing GRAMDECK! Send for FREE Book today!

DEPT. TP/810 GRAMDECK

29, WRIGHT'S LANE, LONDON, W.8

ADDS A SUPERB TAPE RECORDER TO YOUR GRAMOPHONE

YOU GET *Vivid* REALISM...

...with the
wonderful



HMV TAPE RECORDER

Speech, music, sound effects . . . you get VIVID REALISM every time with this fine tape recorder. This isn't surprising when you consider its many 'professional' features. What is surprising is that such a quality machine should be so modestly priced. Hear it at your dealer's and you'll realize that "His Master's Voice" offers TODAY'S FINEST TAPE RECORDER VALUE!

- * Two speeds: $7\frac{1}{2}$ i/s and $3\frac{3}{4}$ i/s
- * Frequency response: 50-10,000 c/s at $7\frac{1}{2}$ i/s \pm 3dB
- * Takes 7" spools
- * Half-track operation
- * Three-motor drive
- * Separate record and playback amplifiers
- * Three head system for instantaneous playback
- * Pause control for instantaneous stop/start



ONLY £50

Complete with 1,200' Emitape, spare spool and crystal microphone.



THE GRAMOPHONE COMPANY LIMITED · HAYES · MIDDLESEX

“One of the best I have used”

WRITES J.G. IN “THE GRAMOPHONE” AUGUST, 1960, IN REVIEWING THE

LUSTRAPHONE VR/65 STEREOPHONIC MICROPHONE

“Frequency response meets the manufacturer’s specification, that is, substantially flat between 15-13,000 c/s Undoubtedly the most convincing demonstration of the superb characteristics of the Lustraphone microphone came during the rehearsal (of) Beethoven’s *Egmont* Overture and *The Planets* of Gustav Holst. . . . From the deepest tympani to the crash of cymbals the ‘Stereomic’ picked up every note with its correct position in space and without any sign of distress. . . . This, the first full review, confirms all that has been written before, and I would place it as one of the best microphones I have used during many years of work in this field.” J.G., “*The Gramophone*” Aug. ‘60, page 151.

THE LUSTRAPHONE “STEREOMIC” DUAL RIBBON MICROPHONE VR/65 COSTS 30 GNS. VR/65NS STEREO RIBBON—15 GNS. DETAILS OF THESE AND OTHER MODELS ON REQUEST.



BRITISH-MADE DYNAMIC & RIBBON MICROPHONES

LUSTRAPHONE LIMITED PRImrose 8844
ST. GEORGE’S WORKS, REGENTS PARK ROAD, LONDON, N.W.1.

NEW FORMULA

Sound machine + Psycho-tapes or Discs = SUCCESS

SEND NOW for interesting 16 page FREE BOOKLET which will show you how to:-

- ★ DEVELOP PERSONALITY
- ★ GAIN SELF-CONFIDENCE
- ★ TRAIN YOUR MEMORY
- ★ LEARN SELF-HYPNOSIS
- ★ SPEAK IN PUBLIC, etc.

To EDUCATIONAL RECORDINGS, Dept. 10, 27 York Road, Ilford, Essex.

Please send 16 page free booklet in plain package

Name

Address

TAPE RECORDING HANDBOOKS

Written by four enthusiasts, experts in their own particular field, these handy-sized guides to four aspects of tape recording should find their way into the pocket of anyone interested in hi-fi and tape recording. A MUST for the newcomer.



INTRODUCTION TO THE TAPE RECORDER

Charles Langton
3/6 (4/- inc. postage)

HI-FI FOR THE MUSIC LOVER

Edward Greenfield
3/- (3/6 inc. postage)

TAPE AND CINE

John Aldred
3/- (3/6 inc. postage)

HOW TO RECORD WEDDINGS

Paul Addinsell
3/- (3/6 inc. postage)

Available from:
Tape Recording and Hi-Fi Magazine
7, Tudor Street, London, E.C.4

hi-fi perfection with enough volume to fill a small hall on BATTERY or MAINS

Walter
TRANSISTOR

BIG OUTPUT!

**BIG 2 WATTS
UNDISTORTED**

BIG REELS!

**5 3/4" TO GIVE 3
HOURS PLAYING TIME**

**The only BIG recorder
with BIG performance
on MAINS or BATTERY**

Note these other features:—

Revolution counter • Transistorised
Mixing facilities • Superimposing facilities
40/15000 cycles amplifier response
Signal/Noise ratio better than -40db.



55
GUINEAS
(Batteries extra)

**The WALTER records or plays Outdoors
or Indoors . . . anywhere . . . everywhere**

Double your fun with this revolutionary tape recorder. It makes you independent of mains electricity supplies; yet it's full size (takes 5 3/4" reels) and gives you BIG 2 watt output and faithful reproduction on batteries or on mains.

WALTER INSTRUMENTS LIMITED, GARTH ROAD, MORDEN, SURREY. Tel: DERwent 4421

FRANCIS OF STREATHAM

- ★ COMPLETE T.R. SPECIALISTS
- ★ LARGEST SELECTION OF LATEST MODELS
- ★ SEPARATE HI-FI DEPT.

● The Centre for Prompt Personal Attention and respect for your Pocket

NO EXTRA FOR CREDIT

Minimum deposits and no interest or charges on H.P. up to 18 months. FREE SERVICE WHILST UNDER GUARANTEE

HIRE SERVICE

Tape Recorders available on hire from 45/- per week

MICROPHONES AND MIXERS

	£	s.	d.
Lustraphone VR/65 NS Stereo Ribbon	15	15	3
Lustraphone LD/66 New Dynamic	4	2	6
Lustraphone "Lustrette" M/C	3	7	6
Lustraphone VR/64 Ribbon	7	17	6
Lustraphone LRV/59 Dynamic	8	18	6
AKG Dynamic Stereo D. 88, High Z	19	19	0
Simon "Cadenza" Ribbon	10	10	0
Simon "Cadenza" Crystal	3	13	6
Reslo Ribbon	8	15	0
TSL 3-Channel Mixer	2	2	0
Grundig Mixer	16	16	0

Also by Ronette, Acos, etc. We will gladly advise on the type best suited to your requirements

HI-FI AND ASSOCIATED EQUIPMENT (AT 181 STREATHAM HIGH ROAD)

	£	s.	d.		£	s.	d.
Rogers Junior FM Tuner	25	15	2	Lenco GL/58 cartridge	19	17	6
Armstrong ST.3	26	gns.		Garrard 301	22	7	3
Decca ffs P.U.	20	19	5	Garrard 301/strob.	23	18	4
Dulci AM/FM	23	15	8	Garrard 4HF	18	9	9
Jason FM	22	15	8	Leak Stereo 20	30	9	0
Jason JTV/2	25	7	3	Tannoy Cartridges			
Jason "Monitor"	19	16	3	Loudspeakers by—			
Jason J.2-10/MK III	40	19	0	Expert, W.B., Pye, Goodmans,			
Quad Amplifier	22	10	0	Wharfedale, etc.			
Quad II Control Unit	25	0	0	*Brenell Mk. V	64	gns.	
Collaro 4T200...	18	13	0	Brenell 3 Star	58	gns.	

TAPE TO DISC AND TAPE COPY SERVICE

*Brenell 3 Star Stereo	89	gns.	*Saba ...	79	gns.
Coscor 4 Track	37	gns.	*Simon SP4 ...	95	gns.
Elizabethan Avon	27	gns.	Simon Minstrelle	39	gns.
Elizabethan "Princess"	39	gns.	Spectone 161	49	gns.
*Elizabethan Major	65	gns.	Spectone 171	39	gns.
Elizabethan 4-Track	39	gns.	Stella 4 Track	37	gns.
Elpico TR.400	26	gns.	*Stella 4 Track	59	gns.
*Ferrograph 4AN	81	gns.	*Telefunken 76 4 Track	64	gns.
*Ferrograph 4AN/H	86	gns.	*Telefunken 85 KL	79	gns.
*Ferrograph 4AN/S...	88	gns.	*Telefunken 75/15	54	gns.
Fidelity Argyll	105	gns.	*Telefunken 76	62	gns.
Gainsborough	29	gns.	Uher Universal	79	gns.
*Grundig TK60 Stereo	39	gns.	*Uher 4 Track Stereo	103	gns.
Grundig TK20...	128	gns.	*Vortexion WVA	£93 13 0	
Grundig TK24...	52	gns.	*Vortexion WVB	£110 3 0	
*Grundig TK25	62	gns.	Wyndor Victor	45	gns.
*Grundig TK30	72	gns.			
*Grundig TK35	83	gns.			
*Harting 4 Track Stereo	86	gns.			
H.M.V.	£50 0 0				
*Korting 4Track Stereo	68	gns.			
Magnafon	39	gns.			
Philips 4 Track 3541...	34	gns.			
Philips 4 Track 3542	59	gns.			
Philips 4Track Ster. 3536	92	gns.			
*Reflectograph A-1 Track	95	gns.			
*Reflectograph B-1 Track	105	gns.			

TRANSISTOR MODELS

Butoba	69	gns.
Grundig "Cub"	26	gns.
Clarion	25	gns.
Clarion Twin Set	8	gns.
Minivox	37	gns.
Minivox 2-speed	41	gns.
Fi-Cord	59	gns.
Stuzzi "Magnetite"	69	gns.
Stuzzi de luxe	75	gns.
Steelman	55	gns.
Trav-Ler	29	gns.

ALSO Pre-Recorded Tapes by Saga and "Music on Tape," etc. Tapes of every size and type by leading makers ready for prompt dispatch. *Microphone extra

169-171 STREATHAM HIGH ROAD, LONDON, S.W.16

Between St. Leonard's Church and Streatham Station

STReatham 0466/0192

Hi-Fi Dept. 181 STREATHAM HIGH ROAD, S.W.16



the FINEST TAPE RECORDERS on INTEREST FREE TERMS

Write, Phone or Call today. You can buy by post with perfect confidence Deposits from 20 per cent, 12 months to pay

I know how difficult it is to choose the Tape Recorder. That is why more and more people come to the Royal Opera Arcade, because my advice, personal attention, and help are freely given. Full demonstrations at any time and you can always examine and hear the latest and most interesting machines. Remember—I am here to help you.

LAURENCE DICKINSON

Leaflets gladly sent if you are unable to call



NEW! 4-Track Monaural Recorders

PHILIPS 59 gns. TELEFUNKEN 64 gns.
4-Track Stereo/Monaural Recorders
PHILIPS 92 gns. HARTING 86 gns.
KORTING 68 gns. ELEKTRON 77 gns.

ACCESSORIES. We carry a wide range of microphones, earphones, leads, telephone adaptors, etc., etc.

SERVICING. We undertake rapid and efficient servicing of all Tape Recorders.

TAPES. Audio, Agfa, B.A.S.F., E.M.I., Geloso, Scotch Boy, Telefunken, etc. Send for lists.

CAMERAS. By Zeiss, Agfa, Eumig, Voigtlander, etc. Send for lists.

READ the all-in-one Tape Recorder Book. 12s. 6d. Packed with information.

TELEFUNKEN DA CAPO RADIO, 39 gns. Call and hear this fine instrument.

TELEFUNKEN TAPE DECK, 63 gns. Use it with your amplifier or with the Telefunken Radio.

Dickinsons of Pall Mall Ltd. 11 Royal Opera Arcade, Pall Mall, S.W.1 TRA 2881

The Royal Opera Arcade lies behind Her Majesty's Theatre in the Haymarket (one minute from Piccadilly Circus or Trafalgar Square)

Model	Gns.
Philips 3515	32
Sagatone	38
Elizabethan Princess	39
Simon Minstrelle	39
Perth Saja	45
Wyndor Victor	45
Elektron	47½
Magnafon	49
Spectone Ex Tape	49
H.M.V.	£50
Grundig TK20	52
Telefunken 75 with mic.	56
Perth Saja De Luxe	56
Brenell 3-Star	58
Veritone	58
Mobile	58
Ficord	59
Grundig TK25*	62
Telefunken Deck*	63
Korting Stereo*	68
Telefunken 4-track with mic.	68
Stuzzi-Magnetite	69
Brenell MKV with mic.	69
Grundig TK30*	72
Brenell Mk.V with meter, mic.	74
Elektron Stereo*	77
Telefunken 85KL*	79
Sabafon Automatic*	79
Harting Stereo*	86
Timbra*	89
Simon SP4*	95

* Excluding Microphone.

FREE H.P.!

WE HAVE THE BIGGEST SALES IN GT. BRITAIN
WHY? BECAUSE WE GUARANTEE YOU
THE BEST TERMS!



- ★ No interest charges ★ 2 years to pay
- ★ Deposits from 10% ★ Any machine

SPECIAL DISCOUNTS ★ FREE SERVICING—NO CHARGES ★ BUY FROM US—THE LARGEST MAIL ORDER DEALERS,
WHEREVER YOU LIVE ★ FREE DELIVERY ANYWHERE IN U.K. ★ NO PURCHASE TAX

400 machines, 80 different new and secondhand models on permanent demonstration in our showrooms ★ Open all day Saturday
★ All accessories in stock or sent by Mail Order ★ Main Agents for all the best makes ★ Our Mail Order department specialises
in orders by post with thousands of sales throughout England, Wales, Scotland & N. Ireland ★ Excellent commission paid on any
sales you make for us

WRITE, PHONE OR CALL NOW FOR FREE BROCHURES AND FULL DETAILS OF OUR TERMS:

HOWARD

PHOTOGRAPHIC

218 HIGH ST. BROMLEY. KENT. RAV 4477

NOW AVAILABLE

TAPE RECORDING

AND HI-FI **YEARBOOK 1960-61**

COMPLETE CATALOGUE OF EVERY
TAPE RECORDER ON THE MARKET

SIMPLY PRESENTED IN NON-
TECHNICAL LANGUAGE

FULLY ILLUSTRATED

PRICE—SIX SHILLINGS



..... **POST NOW to: 7, Tudor Street, E.C.4**

Please send me.....copy(ies) of Tape Recording and Hi-Fi Yearbook 1960-61 at 6s. a copy post free. I enclose remittance herewith.

Name.....

Address.....

.....

FOR THE RECORD

CHOOSING a tape recorder calls for sound judgment (if you'll excuse the pun). We can't all have a fund of electronic and mechanical knowledge to draw on. But if we're wise we shop around with our eyes and ears wide open. We listen to every make within our reach and pocket. What's more we note which models are being demonstrated through their own speakers and which through some non-included-in-the-price external equipment.

That's only one of the many important ways in which the WyndSOR "VICTOR" scores. The WyndSOR Recording Company is one of the most experienced manufacturers having been specialising in nothing but quality tape recorders now *for ten years*. They know that a good-sized quality speaker is essential for reproduction of music faithfully and the WyndSOR "VICTOR" has this very feature.

Of course, if the amplifier isn't up to much it wouldn't matter, but WyndSOR have designed a special amplifier which has pre- and post-emphasis networks. They also guarantee that every tape recorder which leaves the WyndSOR factory is not only tested and measured to ensure it achieves the published specification, but is also equalised to C.C.I.R. International Standards. Play a professionally pre-recorded tape on any WyndSOR tape recorder and you'll hear what that means.

It also means that with the WyndSOR "VICTOR" you can make your own professionally-sounding recordings and you can mix and fade music and speech, all with finger-tip control of the most simple-to-operate group of controls on any tape recorder.

Write for a leaflet and the name of your nearest stockist to the modestly proud makers of the best sounding tape recorders in the middle-price bracket. There is nothing more annoying than hearing a WyndSOR just after buying an ordinary tape recorder.

* frequency responses:—

7½ i.p.s.—50 to 15,000 c.p.s. better than ±3 dB.

3½ i.p.s.—50 to 9,000 c.p.s. better than ±3 dB.

1½ i.p.s.—50 to 5,000 c.p.s.

* full frequency equalisation *at all speeds*.

* 10" × 6" elliptical speaker in detachable lid.

* up to 8 hours playing time on one D.P. tape.

* monitoring through its own speaker with independent control.

* finger-tip controls closely grouped.

* mixing facilities for mic and gram/radio inputs.

* additional output with automatic speaker cut-out.

* facility for use as an amplifier.

* three independent 4-pole motors.

* unique styling in two-tone grey with gilt fittings.

* twin tracks * pause control * tone control.

* guarantee: 12 months (valves 90 days) and the name of WyndSOR.



the WyndSOR "VICTOR" complete with crystal microphone, 1,200 feet of tape, and spare jackplug, is only 45 guineas.

WYNSOR RECORDING CO. LTD.

(Contractors to H.M. Government)

WyndSOR Works,
2 Bellevue Road,
Friern Barnet, London, N.11

Telephone: ENTerprise 2226/7
Telegrams: Wyndreco, London

TAPE

RECORDING
AND HI-FI MAGAZINE

Vol. 4 No. 19 21st September, 1960

Tape Recording Fortnightly Magazine is published on alternate Wednesdays, by Print and Press Services Ltd., from 7 Tudor Street, London, E.C.4

EDITOR: R. D. BROWN

TECHNICAL ADVISORY EDITOR: CHARLES LANGTON,
A.M.Brit.I.R.E., A.M.Inst.E.

MUSIC: EDWARD GREENFIELD
The Guardian recorded music critic

DON WEDGE
News Editor, New Musical Express

MOVIE-MAKING: JOHN ALDRED

NEWS AND CLUB ACTIVITIES: FRED CHANDLER

OVERSEAS CORRESPONDENTS:

FRANCE: GEORGE GINIAUX
Revue du Son, 40, rue de Seine, Paris-6e

U.S.A.: PETER M. BARDACH
210-16, Grand Central Parkway, Queens Village 27, New York

The Editor is always glad to receive articles, news items, illustrations, etc., intended for publication and payment is made on the first of the month following publication. When not accepted, material will be returned if a stamped addressed envelope is enclosed, but the Editor cannot accept responsibility for the safety of such material.

"Tape Recording Fortnightly Magazine" is available from 7, Tudor Street, London, E.C.4., by a postal subscription at 45s. per annum, post free, or it can be obtained at newsagents, bookstalls and radio and music dealers. In the event of difficulty, write to the distributors, Trans-World Circulation Co., Park Royal Road, London, N.W.10.

Back numbers, if still in print, are available at 2s. 6d. per copy for issues up to November 1959, and 2s. per copy for later numbers.

EDITORIAL

Address all communications

7 TUDOR STREET, LONDON, E.C.4
FLE 1455-6

ADVERTISING

All advertising communications to

1 CRANE COURT,
FLEET STREET, LONDON, E.C.4

FLE 0197

IN THIS ISSUE

We take the view . . . 10

The World of Tape 11
A News Digest

Travels with a tape recorder 12
Mary Mather

See you in Church 14
Denys Killick

How to choose a midget recorder 17
S. M. Wheatley

Making the Tape of the Year 18
Norman Paul

Reducing wow and flutter 20
L. Reid

Sound Effects 22
Alan Edwar Beeby

Equipment under Test 23

Opportunities for Clubs 24
David Dove

Stereo Notes 26
Douglas Gardner

New Products 27

Letters to the Editor 29

News from the Clubs 31

We take the view . . .

A DIGEST OF NEWS, COMMENT AND EDITORIAL OPINION

THE 1960 Radio Show provided a splendid tonic—at just the right moment. As I indicated here recently, some people in the business had been getting a little jittery of late. They approached the Radio Show with apprehension. And what happened? The public turned out in greater numbers than anyone had thought possible, displaying record interest in new products on show.

And tape recorders figured very much in their enthusiasm. When Mr. Archie Sutherland, of Philips Electrical, spoke on behalf of the industry as a whole, he rightly made a point that tape recorders have gone through “the cycle of a luxury for the few to something for the many” more quickly than any other article in recent years.

That sums it up. Tape manufacturers are now on the threshold of a mass market and the prospects ahead are bright.

It is notable that practically every big firm in the radio and TV field has now jumped into the tape recorder market. Ekco, Ferranti and Kolster-Brandes are the latest “big names” to join our fraternity. Inevitably, the volume of advertising and publicity devoted to tape is going to increase and public interest must take a big surge forward.

Plans . . .

IN this mood, it is appropriate to look forward and to plan boldly. I found it an especial pleasure to join the team in the first of the new series of BBC Network Three “Sound” programmes last Sunday, for these broadcasts are going to play an important part in educating a rapidly increasing audience.

With the same thought in mind, it was an exciting experience to see how the British Amateur Tape Recording Contest took a major stride forward this year. Five weeks hence I hope to be in Holland for the International event and I go there with great confidence that British tape recording enthusiasts are now pace-setters.

Tape Recording Fortnightly has made some interesting plans for the future. I

think we may reasonably claim to have been the pace-setters in tape recording journalism—and we intend to keep our position way out in front of the field!

The most significant development of 1960 is quite clearly the trend towards battery portable recorders, opening up an exciting new world of out-of-doors recording. This field will be fully dealt with in this magazine and, to direct our specialised coverage, we have signed up the man who is widely known as “the King of the Midgets”—Mr. S. M. Wheatley, who recently retired from the BBC after supervising the training of staff in the use of battery portables, from the day they were first introduced there. The first of his regular series of articles appears in this issue.

. . . for . . .

A RECENT series of articles by Alec Nisbett, one of the studio team which has been responsible for the BBC “Sound” programme, attracted a lot of interest. Mr. Nisbett has now prepared a further series, revealing more fascinating information about BBC techniques and drawing lessons that will be valuable to the amateur. The first article, comparing professional and amateur methods of ensuring correct recording level, will appear in our next issue.

Denys G. Killick has contributed a number of notable articles to our columns; he has a racy style which communicates the zest with which he approaches his hobby. His speciality is the composition of feature-documentary tapes.

If you are interested in this creative side of tape activity, you will follow closely the results of a new commission which we have given Mr. Killick. He is to combine the roles of explorer, experimenter and artist. He will be part-teacher and part-roving reporter.

Readers who have it in mind to make a feature-documentary tape, but who are worried about some of the difficulties, are invited to write to the Editor. A tape of a children's party, or of a local cup final, or of an evening at the youth club, or of a day at the seaside? Denys Killick will tackle any of these—or any other subjects you suggest.

He will explain how he approaches the task, what equipment he uses, what preparations are necessary, the actual recording techniques he adopts, and how he fashions the recorded material into a final programme.

This will be the most valuable series of articles offering practical advice on

recording that has ever been published. Send in your ideas and requests now.

. . . the . . .

AMONG the growing mass of recording enthusiasts there is a steadily increasing number of “back-room boffin” types who like to apply their skill in home construction. We shall be at pains to satisfy their needs.

For those who are making a modest start with this type of activity we shall publish in an early issue a short description of how to convert the popular Collaro Mark IV deck for stereo.

For those with confidence to tackle bigger things, we plan a notable series of articles describing how to construct a stereophonic mixing preamplifier. This will be a fascinating item of equipment for the real enthusiast; nothing of the sort can be purchased on the market at the present time; nothing has been published elsewhere about the problems of constructing such a mixer.

This issue contains an article directed at tape club members and, with the approach of winter, we shall be paying special attention to their needs and interests. One very special project is now being worked out and details will be announced shortly.

. . . future

IN addition to the new features indicated above, we shall, of course, maintain the high standard of the old favourites. An engrossing series of articles on overseas travel with a recorder has been lined up; with so many new recorders coming on the market, we plan to increase the number of test reviews by our panel of technical experts; there will be articles on the use of tape in the theatre, including stereo recording of drama and tape used with puppets.

And, of course, we shall provide the essential leavening of humour, with light-hearted articles and the best tape cartoons. In the next issue we introduce a new character—Willy, whose activities put a comic edge on some familiar heart-rending experiences.



The Audio Hall Stand of "Tape Recording Fortnightly" displayed the full range of publications, including the straight-from-the-press "Yearbook" and "Advice on Buying a Tape Recorder" booklet. The special staff on the stand were plied with questions about the magazine and about the displays of the various manufacturers. Notable among our customers were the high percentage of younger enthusiasts.

THE RADIO SHOW POSTSCRIPT

A FINAL count-up of the attendances at the 1960 Radio Show gives a clear indication that the public is as keen as ever to keep up to date with the trend in audio and visual equipment manufactured by British concerns. The latest figures show that 35,269 more persons attended this year than did in 1959. Total number of attendances for 1960 are 340,276 against 305,007 for last year.

An all time record of 24,644 attended the opening days on August 24, compared with the 15,754 which found their way to Earls Court on the 1959 opening day. Attendances each day have been consistently higher. The lowest increase was for the first Friday of the exhibition, when a total of 1,054 attendances was added to the 1959 figure of 23,945.

THE WORLD OF TAPE • A NEWS ROUND-UP

TAPES FOR BLIND ENTHUSIASTS

A NEW national organisation to cater for blind tape enthusiasts has just produced an initial series of tape-recorded features for general distribution. It plans monthly issues, to be issued on an annual subscription basis.

The need for a new national organisation was outlined in *Tape Recording Fortnightly* recently, and this was followed up by a meeting, late in August, between Charles Standen, F. C. Gazeley and Angus McKenzie on the one side and the Cultural Society of the Disabled on the other.

A decision was reached to issue nine tapes each month. One will contain readings from *Tape Recording Fortnightly* and other tape magazines. Others will present material from the Consumers' Association magazine *Which?*, from women's magazines, and from humorous publications.

A fifth regular tape will take the form of a general digest, another will be a sound magazine covering railways, flight and cars, another will deal with science and discovery.

Then there will be a regular travel magazine on tape, including as many on-the-spot recordings made with portables as can be secured. Finally, there will be a personal programme to be known as "Rupert Gillard's Digest."

Nine master tapes will be produced at 7½ ips on 1,800 ft. tapes and six copies of each will be made at 3½ ips on 5¼-inch reels by Angus McKenzie and his staff at Olympic Sound Studios, on a voluntary basis. Special arrangements will be made for any blind persons whose recorders will not take spools of more than 5-inch diameter.

The tapes will be published on the second Sunday of each month and will be posted to all blind persons who decide to register for the service. The cost will be 25s. a year, to cover the cost of postage on the tapes.

All who are willing to help with this scheme should write to Mr. F. C. Gazeley at 12, Bromley Road, Beckenham, Kent. The scheme is flexible until demand and material requirements can be gauged. All who are interested will later be invited to a special meeting to discuss plans.

Meanwhile, tape sufficient for the first issues has been donated by Angus McKenzie.

The society is being registered as a charitable organisation.

Electronic music demonstrated

STUDENTS at the famous Dartington Hall Summer School of Music this year made acquaintance with electronic music on tape. Two distinguished practitioners, Bruno Maderna and Marc Wilkinson, directed a class for composers and others interested in this new technique.

A late-night recital of electronic music consisted of works by Maderna, Luciano, Berio and Karlheinz Stockhausen.

A hitch with the twin-channel tape machine led to improvisation of a pseudo-stereophonic system, with speakers around the audience. Monaural copies of the tapes were used and Bruno Maderna showed great virtuosity in the operation of the controls of a stereo amplifier to secure the most effective reproduction of the interesting compositions which had originated in German and Italian electronic music studios.

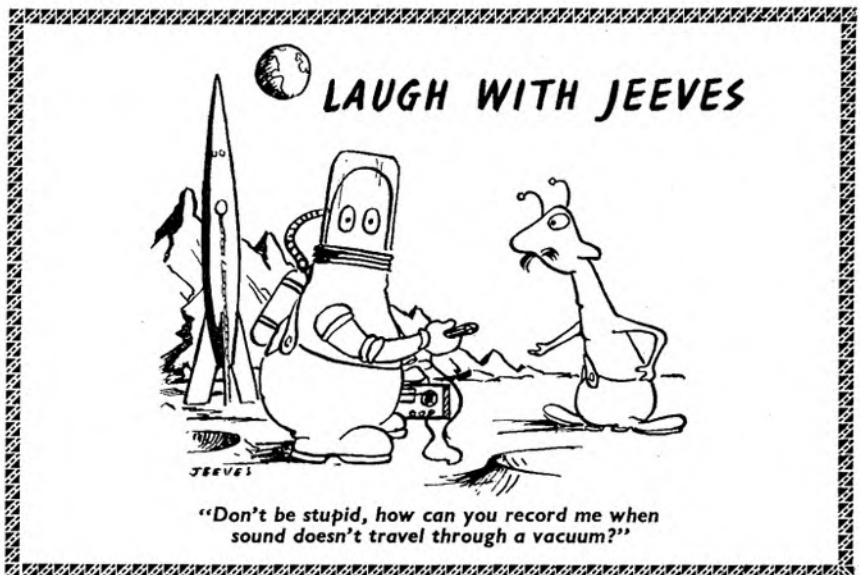

OVERLAND TO INDIA

TWO months before setting off on the overland drive to India, we decided that, in order to "do the thing properly," we needed a general-purpose tape recorder. We considered, and rejected, the idea of running a mains model from the car battery with an adaptor: our range would be too limited, and the set-up too clumsy. So we looked around for a transistor model that was not too expensive, not too hard on batteries, and would be rugged enough to stand extremes of heat, cold, damp, dust and vibration.

Search through the pages of tape magazines indicated the choice that was open to us and, after some heart-searching, we finally chose the Stuzzi. It had two speeds, $1\frac{1}{2}$ and $3\frac{1}{4}$ ips, a magic eye for volume control, a counter which helped quick and accurate playback, a safety catch to prevent erasure by mistake, and it used standard tape reels. It could run either flat or standing up, and had a plastic, removable window over the reels so that, though there was protection from dust while operating, one could still keep an eye on the "works." Above all, and this was what clinched our decision, its four torch batteries would run for up to 100 hours.

The next problem was finding a home for it in the car, an Austin Gipsy with fibre-glass top. It had to be handy, ready for quick action, but it must also be cushioned against jolts and bumps. In the end we made a wooden compartment lined with foam rubber behind the driver's seat. The side was open so that I could plug in the microphone and use the controls without taking the machine out. A set of Extra Long Life batteries was fitted, and one set of spare batteries, plus spare reels, were carried separately in what we fondly, but as it turned out, vainly hoped was a dust-proof tin.

We left in March, on the Dover-Ostend ferry, and reached Zagreb, where we have Yugoslav friends, in two days. We had pre-recorded family messages and extracts from our favourite records for them, but when it came to playing back, our Stuzzi was blotto. Not a sound or a movement. As I had already had ratchet trouble with my camera, and the roof-rack had bounced off the Gipsy as we lurched through a pot-hole, the



A modern-day Volkswagen passes in front of the timeless mosque at Lahore, Pakistan

Yugoslavs had a good laugh at the "harassing mechanical contraptions" of the civilised West!

We soon discovered what had gone wrong. Either through my carelessness or through the joltings of the car, the "Off" button was not depressed. The motor had been on since leaving England and the batteries were absolutely flat. So much for Extra Long Life batteries!

In went the spare batteries, but it was a mistake to ditch the others, for we later learned in India that it is both easier and more satisfactory to have your old cases refilled than to buy new batteries of this shape and size.

Wanting to get over the first stage of our journey as quickly as possible, we reached Ankara, capital of Turkey, in a further three days' driving, then headed for Samsun, and along the Black Sea coast to Trebizond.

The scenery was so magnificent and the people so picturesque that it seemed a suitable time to try out our idea of a running commentary as we drove.

This was not as simple as we thought. The sound of the engine—an unusually noisy one—almost completely blotted out my voice. I tried wrapping up the microphone in a cardigan, leaving only a pin-point hole at the front. This was better. Then I turned down the volume to its lowest and spoke in a whisper, close to the mike. The result was good, and even

better when I switched over from $3\frac{1}{4}$ to $1\frac{1}{2}$ ips.

Using this technique, we got one of the most vivid and amusing recordings of our whole journey. It starts off with a description of sea on our left, snow-capped mountains to our right, and a lorry-load of Turkish peasants in front, moves on to an argument about what time and where we had gone to bed the night before, and ends up with an almighty crash as if the entire washing-up had shot on to the floor. Then, in the ensuing quiet, a surprised male voice gurgles: "That was a nasty hole in the road. Ha-ha-ha! Really . . . I thought we were going to collapse."

We were hoping, of course, to record local music and singing, but no opportunity came our way until we reached Quetta, in Pakistan. As we drove in, there was the sound of distant drumming, and the streets were full of Pathan tribesmen with their huge turbans, flowing robes and beards. We made our way to the open space where the crowds were milling, and I slung a haversack with colour and movie cameras over one shoulder, and home-made haversack with Stuzzi on the other, before joining the throng.

Though I was the only woman there, and perhaps the only unveiled woman to be seen in public, cameras and recorder were a sure passport to success. I soon found myself pushed to the centre of the whirling rings of

MARY MATHER

contributes this
article in our
regular series on

●● TRAVELS WITH A ●● TAPE RECORDER

dancers. I could have done with a lapel microphone, but improvised by threading the wire through my blazer buttonhole. When I switched on, my hands were then free to work the cameras. I felt like a B.B.C. mobile recording unit in miniature.

The great thing, of course, was that, while I was unable to show my films immediately, I could play back the recordings, and this aroused almost more interest than the live performance.

On the strength of it, we were invited to the house of the local magistrate, where a crowd of delighted Pakistanis listened in to the music and then tried out their own voices. We made friends and also a fine tape of a discussion about local methods of justice. It seems that criminals almost invariably came and confessed their own crimes; where they did not, the family or tribe were held responsible for bringing them to book, otherwise they themselves suffered a collective punishment!

Later that day I was allowed to visit a closely-guarded harem, and again the Stuzzi played a major part. The women crowded round me eagerly, but what could we do, without a single word of common language? Then I



switched on and let them hear the men's singing and dancing.

Wonderful! They couldn't believe it! I let them hear their own voices, and the playback was so riotous and so frequently punctuated by shrieks of laughter that I had to keep my finger on the pause button so that no one should miss herself.

Though photographs were forbidden—on pain of death, so I was made to understand by gestures—they so far forgot themselves that, at the end, I was allowed to take several colour shots of the women and girls. "Not to be shown to any men," I was told, firmly and unmistakably, in sign language!

We were now getting used to what the Stuzzi could do for us, socially as well as mechanically, and later we found ourselves at home and welcomed in the strangest of places: recording poems in Urdu at midnight in the courtyard of a local landowner;

picking up from a loudspeaker the Muslim liturgy sung in a mosque; catching fragments of a discussion on philosophy in a Bengali tea-house; and taking down conversations, songs and music wherever we went.

Except once, when sand got into the gearing mechanism and caused the reels to turn jerkily, we had no mechanical or reproduction trouble. Even this cleared itself after a short time. And only one further set of batteries was needed, bought without much difficulty on our return passage through Delhi.

We are now back, with a tinful of tapes that need marking. Played even at random they have given a great deal of nostalgic pleasure to us, and interest and amusement to our friends. But I must hurry with that marking. My fame has spread abroad. Next week I have been invited to a local charity garden party free of charge—with the Stuzzi!



(Top of page) The Harem at Quetta, Pakistan; not such an exotic assembly as Westerners imagine. (Lower illustration) Traditional dancing at Quetta. The boy dancer in the centre, rouged and lipsticked in Western style, is in a state of semi-trance. Note the bagpipe accompaniment.



*Those who sell
recommend . . .*

SCOTCH
TRADE MARK
BRAND
recording tape



WORLD'S LARGEST SALES OF MAGNETIC TAPE

“W-o-o-o-o . . . w.” A howling scream cut through the dark still air. No, it is not a ghost story. You can discover the answer by accepting the invitation:

See you in Church

“Tape recording is meant to be fun!”

As my wife spoke the words, she had a malevolent glint in her eye. The huge wicker basket in her hand was placed gently on the pavement with a groan of relief. Turning, she waited for me to struggle up in the rear, staggering under the weighty bulk of the Grundig TK 820. It was a bitterly cold night, with a white sparkle of frost in the air, yet as I put the machine down I wiped the beads of perspiration from my brow with the back of my hand and opened my coat to the bite of the east wind.

Fairy lights twinkled in a window across the road and from somewhere in the far distance came the sounds of a lone, wandering caroller. The wind began to chill, and without another word we picked up our loads and covered the next hundred yards in the direction of the church, before resting again.

I had been thrilled when the vicar asked me if I would be kind enough to record the service of lessons and carols. From previous conversations, he was well aware of my enthusiasm for recording.

I had been inside that church on numberless occasions, but now, with the immediate urgency of this project in mind, I carried out a swift survey of the conditions under which I should have to operate. There was only one power point available, on a wall about two-thirds of the way back from the front row of pews. The pulpit was farther away than I would have believed possible. The choir, who would of course be the principal performers, had their stalls still farther back, behind the chancel steps. And what about the lessons? The lectern, I realised, was perched in a most awkward position. As I stared at it resentfully, its eagle's head stared dumbly back. A door banged and its hollow sound reverberated through the arched heights of the building. Quietly I tiptoed out with a nasty sinking feeling in the pit of my stomach.

Back at home, I looked at my machine. I looked at my microphone. There was no need to measure the length of its cable; just eight feet, not an inch more.

“I suppose the organ will come out all right?”

My wife startled me out of a depressing reverie. The organ? I had not even thought about the organ. But then

By

DENYS G.

KILLICK



organs make lots of noise. They have a notorious habit of filling even the greatest churches with surges of solid, rolling sound. The organ can always be heard wherever one happens to be. Even my little microphone could hardly fail to gather up some of the more meaty chunks of organ noise. I might ask Miss Smithers, the organist, if she could please play double forte all evening to make quite sure.

"Oh yes," I muttered, "I think the organ will come out all right."

The next day I knew it would not do. Should I politely regret my inability to the vicar and hope the episode would soon be forgotten, or should I buy, beg or borrow the assortment of accessories so obviously necessary?

I made a rough sketch of the interior of the church. The power point would be there; mark it with a cross. A little circle by the pulpit is one, another at the foot of the chancel steps is two, and a third little circle goes by the lectern. Minimum requirement, three microphones. The organ would have to look after itself.

How about cable lengths? I judged the greatest distance between my little circles and the cross making the power supply to be about sixty feet, and the shortest probably half that. There was a ledge on the pulpit which would take a table microphone quite comfortably and there was another ledge a little to one side of the lectern where I could possibly place another. Out in the centre of the chancel steps there was nothing except the steps themselves on which to place anything. A floor stand would be the only answer there, but it would have to be fully collapsible so that it could be carried with reasonable convenience.

A telephone call brought the offer of the loan of a table microphone, together with a thirty foot extension cable, which I gratefully accepted. A heated discussion with my retailer produced a long and costly list of accessories. There was the mixing unit to take the output from three microphones, one of which, a low impedance ribbon model, was also on the list. There was a fifteen yard extension cable of one make and there were two thirty foot cables to suit the ribbon microphone. There was the microphone transformer and there was the lead from the mixer to the recorder. The bill came to well over £40; I shuddered as I thought of the effect it would have on my own Christmas celebrations.

The equipment was delivered exactly 48 hours before the service was due to take place. Carefully beginning to wire up, I stopped when I came to my two thirty foot lengths of cable. They were there, as ordered; twin core, balanced line, outer screen, all neatly coiled into two grey circles. But there was no means of joining them together. An ordinary co-axial connector would not suit because this cable had a pair of central wires, not one.

The whole of the next day was spent chasing balanced

(Continued on page 16)



*Those who know
insist on . . .*

TRADE MARK
SCOTCH
BRAND
recording tape



WORLD'S LARGEST SALES OF MAGNETIC TAPE

See you in Church

(Continued from page 15)

line connectors. These were either unheard of, just out of stock or just coming into stock—in a few days' time. Finally, in a radio spares shop many miles from home a bright young assistant produced some metal fuseholders which he suggested could, with a little ingenuity and an unspecified quantity of solder, be contrived into performing the function I required.

The battle of the fuse holders lasted until three o'clock the next morning.

We had to carry all the equipment to the church. Some years previously I had a blind basket-maker make an especially large wicker basket designed to carry the weekly provisions for a family of three healthy young boys and their parents. Into this was packed my miscellany of apparatus.

"My, my! What a lot of things you've had to bring!" beamed the vicar as cable number two snaked its way behind a huge Christmas tree next to the pulpit. "I do hope it wasn't too much trouble for you!"

"Oh, no trouble at all," I smiled blandly.

The placing of the microphones proved to be quite a simple matter, and I listened intently as my wife murmured "Mary Had a Little Lamb" into each of the three instruments in turn. Everything was working. Now a spool of tape to be laced up on the deck, and then switch off and relax until things start.

Relax? I shook with nervous tension under the curious gaze of the arriving parishioners. I failed to notice what the verger was doing up among the holly-decorated choir stalls.

"Look," breathed my wife, "candles! Aren't they pretty?"

On every bench in the choir stood a slim, white candle, and as they were lit their yellow flames gleamed brightly through the sprays of evergreen. I had no time to admire the candles for, at that moment, the vicar, followed by the choir in procession, entered.

Switching on, I started recording in time to catch his opening words. A short prayer, which appeared to be recording satisfactorily, and then the vicar retired into the background. The choir scraped noisily to their feet, the organ pealed out and the first carol began.

At that moment all the lights in the church were put out!

I looked around, panic-stricken. The choir were singing lustily, music held carefully within the light of their candles. Another pair of candles shone like twin stars over the lectern. The rest of the church was in darkness, black as the cover of the great Bible from which the lessons would be read, and the only other light was the green flicker from the magic eye as it winked reassuringly up at me from the deck.

"We didn't bring a torch," I hissed in the direction of my wife.

"No, we didn't, did we," she hissed back, quite unnecessarily.

My shaken confidence returned as lessons and carols alternated and, becoming more accustomed to the darkness, I could distinguish the outline of the recorder in front of me. For a long time I gazed at the green brilliance of

the magic eye, mesmerised by its movement. I began to feel almost happy.

A glance at my watch told me we had been recording for 35 minutes. In another ten minutes the first side of my seven-inch spool would be exhausted and I should have to turn it over. I began to worry; it was too dark to see just how much tape was left. I determined to stop the machine and come back on the other track at the next short break in the service.

A lesson was being read at the time, and the sad, high-pitched voice of an earnest young Sunday-school teacher was nervously issuing from beneath the twin candles in the far corner of the church.

Suddenly it happened. There was a resounding metallic click and then, "W-o-o-o-o-o-o . . . w!"

A howling scream cut through the still, dark air of the church. Gasps from the congregation . . . frightened white faces in the choir . . . A final ghastly screech echoed from the roof and then—silence.

Silence crashed into the dark cavern of the church like a blow from a sledge-hammer. Absolute silence, oppressing, stifling, suffocating, until it was shattered by the slightest suggestion of a muffled cough. A very tiny, gasping voice faltered through the last few words of the lesson.

As the notes of "Hark the Herald Angels Sing" rang out, I recovered consciousness. I found myself with my left hand, dripping with sweat, pressing the power switch into its "off" position. It was then off, but I went on pressing as if it could never be far enough off. The only credit I can claim is that at least I readjusted my machine, turned the tape over, switched on and continued to record the rest of the service. I suppose I could hardly have done less.

The scream had probably lasted for no more than a second. The cause was elementary. In the darkness the stop foil at the end of the tape had arrived more quickly than I had anticipated and the instant it contacted the automatic stop mechanism it threw the machine from record into normal playback condition with its main amplifier turned well up. This is a peculiarity of the TK 820.

The mixing unit was connected to the diode input and, as I had been monitoring through the internal speakers, an acoustic feedback was at once set up through the microphones and the resulting howl was inevitable.

On the Sunday after Christmas my recorder was again taken to church, but this time no candles were lit. As a crowded congregation listened to what even I had to admit was a very fair recording of the Candle-light Service of Lessons and Carols I looked from the brilliance of the great pendant lights above my head to the washed and shining faces of the children in the front row of pews. I knew then it had all been so very worth while.

NUSOUND RECORDING CO.

ferrograph

(Appointed Dealer)

Tape Recorder & Hi-Fi Specialists

Showrooms: First Floor
3-8 BRIGSTOCK PARADE,
LONDON ROAD,
THORNTON HEATH, SURREY.
(Opposite Thornton Heath L.T. Bus Depot)
TELEPHONE: THO 7609

London Showroom:
35 CRAVEN STREET,
TRAFALGAR SQUARE,
LONDON, W.C.2
TEL: TRA 2080



Out with a portable

HOW TO CHOOSE A "MIDGET"

S. M. Wheatley recently resigned from the BBC after 28 years' service, for the last seven of which he was responsible for training staff in the use of battery portable recorders. In future Mr. Wheatley will be writing in "Tape Recording Fortnightly" on the technique of recording with a "midget."

than the same pattern restricted to $3\frac{1}{2}$ inches, even more so at $1\frac{1}{2}$ inches. It is this congestion which limits definition and detail at the lower speeds, in other words the quality and faithfulness of reproduction when revealed on hi-fi equipment.

I feel sure you must have seen demonstrations of wave-form or the pattern of sound on cathode-ray tubes at electronic exhibitions, and you will remember how the pattern could be "opened up" to show a small section of the pattern and how much easier it was then to understand the wave shape. . . . So it is with the very complicated pattern magnetically imparted to the tape in recording the sounds you want.

Imagine the precision required to get between words or cut out an unwanted remark (a likely contingency).

When you think of the hazards of the route that the sound has to take, microphone-amplifier-recording-head, the tape itself, and then the mechanics of its movement—then in reverse for replay—it is a wonder that it all comes out so well in the end.

Ah yes, *Speed*.

Even when you have decided on the speed you must be assured that it is going to be *constant*. This is usually arranged by some kind of governor, either electric or mechanical, or a bit of both, such as a centrifugal switch which operates continuously to keep the speed constant. A small off-speed error either above or below that specified is not a disaster, especially where speech or effects are concerned, but a variation of speed is most undesirable where serious work and music is being recorded.

Steady test tone or a stroboscopic tape viewed under electric or neon light will soon show if the speed is correct or if it is varying. Running the strobe-tape through the heads on to the floor, will establish whether or not the speed is correct as far as the

(Continued on page 33)

THERE is one big advantage, a choice of midget tape recorders. As I write this article it is not known how many will be presented at the Radio Show, but it is certain that more than ever will be available.

What are the most important design features to watch for and what are the "nice to have" ideas, which can be sacrificed if need be?

If you already have a mains recorder, or will be getting one, the obvious thing is to have a standard speed, thus recordings made on the midget can then be played on the mains machine, providing immediate interchangeability of tapes, without the need for initial dubbing.

What determines this choice of speed? It depends very much on how ambitious you are as to the use of the material collected.

If you wish to "place" recordings with the professionals' concern for broadcasting, or do commentaries for that film sequence you are taking, then $7\frac{1}{2}$ ips is the one to use.

For broadcasting, the present internationally preferred speed is 15 ips, but there is a strong possibility that it will soon give way to $7\frac{1}{2}$ ips.

So many improvements have been made to gear in the last year or two, particularly in record and replay head design that the $7\frac{1}{2}$ ips speed is acceptable for first class music recording,

even when sent over V.H.F. F.M. transmissions. The advantages of doubling the playing time per reel are obvious and economic.

What about the two lower speeds— $3\frac{1}{2}$ and $1\frac{1}{2}$ ips? If you already have a mains recorder for these speeds then clearly your midget recorder should operate at one of them.

Three and three-quarter inches per second will be suitable for general use, including music, for purely home entertainment.

For a rare bit of recording, such as a hot news story or a unique eyewitness account, even $3\frac{1}{2}$ ips might be accepted by professional concerns, although $1\frac{1}{2}$ ips would not.

Single track recordings only should be used for broadcasting, because it is impossible to edit one track without mutilating the other one. The confusion which arose in the recording section (small as it was then) when the BBC tried dual track recording on the old Phillips-Miller sound on film system around 1937 was unbelievable. We soon abandoned the attempt.

Now apart from basic quality considerations, what is it that makes the higher speeds desirable? It is ease of editing primarily.

You can well imagine that the magnetic pattern on the tape is much easier to deal with if it is spread over 15 inches of tape, one second's worth,

IN TWO MONTHS WE MADE THE TAPE OF THE YEAR

THE *Rest is Silence* is a simple story, and perhaps a little macabre, dealing as it does with the last few hours in the condemned cell. Nevertheless, it was not written as an exercise in morbidity, but principally to hold up a mirror to our times. Its object is to portray, by a series of flashbacks and contemporary action, the agony of mind which every condemned man, regardless of the crime he has committed, must undergo as his time runs out.

The actual physical writing, including revision and polishing, took just under a week. My next task was to appoint a producer. I was firmly of the opinion that it would be wrong to undertake this myself. I had already written the script, was in charge of the actual recording, was playing a small part, and doing all the sound effects.

Definitely someone else fresh to the script, was needed. My choice was, unhesitatingly, George Halse. George and I have worked together both on the stage and on recordings, and I knew he was the right man for the job.

The next stage was to cast the play. Here we were fortunate in that we are both members of the Mountview Theatre Club, at Crouch End, in North London. This club theatre is recognised as being the most active amateur theatre in the world and it produces a different play every alternate week throughout the year. We had at our disposal, therefore, a galaxy of good amateur talent.

The difficulty was that many of the people we wanted were already busy with stage shows. There are fifteen people in the cast, many of them with only a few lines. We knew it would be impossible to get them all together for a number of set rehearsals and a series of recordings—indeed it would have been highly undesirable for two important reasons:

1. Thirteen actors, plus George and myself, in one small bed-sitting

Norman Paul took top honours in the British Amateur Tape Recording Contest with his playlet "The Rest is Silence." In this article he describes the work entailed in making the tape.

room for any length of time would very soon have become unbearable,

2. The complication of combining actor with effect demanded that very short runs be recorded at one stretch, to avoid a mass application for admission to a mental home.

It was decided, therefore, to divide the script into 22 sections, and to rehearse and record each section, some of them no more than two or three lines, at a time. The basis we worked upon in deciding the sections was the availability of the actors concerned, and the number of effects required.

Two weeks were spent in recording the effects we had decided upon. This was done with a Fi-Cord battery recorder and a Grampian microphone. It may be of interest to mention some of the effects in the script and the method employed to achieve them:

Opening and closing of iron door: A metal filing cabinet drawer opening and closing. Recorded on the Fi-Cord at 7½ ips and played back on an Elon-Collaro mains recorder at 3¼ ips.

Gunshots: A ruler was struck smartly on to a leather chair. Recorded at 7½ ips and played back at 3¼ ips.

Police car bell: Co-operation was obtained with my office switchboard operator, who gave a continuous ring on my phone, while I recorded on to the Fi-Cord. The "approaching" effect was made later when dubbing on to the final effects tape.

Acetylene burner: Two people "hissed" furiously just off mic.

Feet standing on the trap: Various methods were tried here, including stepping on to a weighing machine on an Underground Station, walking on the various trap doors one sees in the pavements throughout the City, leap-

ing on loose-fitting coal-hole covers, and so on. None of these proved satisfactory, mainly because of unwanted background noises. In the end we settled for a metal card index tray. This was taken from its cabinet and laid across two telephone directories and then stepped upon.

Trap door opening: The metal index tray again. This time it was pulled out quickly from it; cabinet and allowed to drop on its hinges.

The final tautening of the rope was achieved by the abrupt tautening of an ordinary necktie a few inches from the microphone. Recorded at 7½ ips and played back at 3¼ ips.

Coffee bar background: A rehearsal break in the Mountview Theatre Club green room. This sequence came into the script twice, once on its own, and again as a background to the youth Roddy, singing and playing his guitar. The first was a straight-forward run, and when used as the background we superimposed Roddy on to the original signal.

Roddy's guitar playing, incidentally, presented a problem. Raymond Walker, who plays Roddy as a youth, is an amateur guitarist with his own group. I already had a tape I had previously made of his singing one or two numbers. Unfortunately, however, they were published numbers and the copyright ogre raised its ugly head. I phoned Raymond and explained the difficulty, whereupon he set to and composed a few bars which were just right for the very short sequence we wanted. I must really get him to finish it sometime!

Other effects used in the production were mainly straight-forward recordings of the items themselves. All effects were then dubbed on to an effects tape at 7½ ips, and divided into



Norman Paul, left, and George Halse

sections corresponding with the script sections with white leader tape. One or two effects we left to be done manually during the actual recording of the play, and these were: (1) Teacups, (2) Draughts, (3) Police whistle, (4) Match striking, (5) Electric light switch.

We were now ready to record. The recording dates had already been arranged (six of them spread over a period of three weeks), and the actors notified of the dates they would be required. We had six scripts. George and I had one each, and we gave one to David Killick who played the lead (Roddy as a man). The other three we dished out to whoever was playing in the particular sections to be recorded on that day.

Even now, some of the actors do not know what the story was all about, having only done their own particular section!

The apparatus used was a Ferrograph recorder and a Film Industries microphone for the recording, and an Elon-Collaro with the effects tape mixing straight into the second input on the Ferrograph. George and I had headphones, but the actors, of course, could not hear the effects, so George brought them in with a cue light, the scripts having been suitably marked up beforehand.

The actual recording took place in my bed-sitting room, except for the two judges' sequences which we did outside on the landing in order to produce the echo effect.

Our method was to rehearse the particular section until we had got it

right, then, rather like showing race-horses the jumps, we would let the actors hear the effects on that particular section, so that they would have some idea of what was going into the second input while they were reading their lines into the first input—and thereby get a better understanding of the cueing.

This worked admirably, although we found that in the sequences where Roddy was on his own, such as where he was running from the policeman and where he was going to the execution shed, it was far better to let him wear the headphones himself and make his own timing.

Two points we had to watch very carefully in recording in sections (especially when sometimes a period of days passed between one recording session and the next) were the question of microphone balance and the mood of the actor.

We achieved uniformity (I hope) in these two points by (a) ensuring that each actor stood in exactly the same place for each of his sessions before the microphone and (b) playing back the previous section (if it had by that time been recorded!) to the actors in the section about to be recorded before doing any rehearsing or recording.

The recording went to schedule and was completed within the three weeks. All that now remained was the editing.

Apart from one or two "fluffs" which had to be remedied, there were twenty-two sections to be assembled in their correct order and spliced to-

gether to run naturally from one sequence to the next. Before embarking on this I took the precaution of making a duplicate of the recordings we had made. In the event of any disaster I knew it would be a ghastly task to try to get the cast together once more. Some were off on holiday, and others were back on the stage again.

All went well, however, and the job was completed in one week, without mishap.

Then came the supreme moment. After weeks of listening to disjointed bits, George and I sat down and listened to the play as a whole.

We sat there while Roddy went through his ordeal. Occasionally one of us would make a note—too loud here, too quiet there, cut a pause here, insert one there, and so on.

As the trap opened—and *The Rest is Silence*, we both looked at our watches, just 13½ minutes—plenty of time for the credits. We were both reasonably pleased with what we had heard, but we both had the same main criticism.

At the beginning it did not seem that the flashbacks came over clearly enough, and it all seemed a little confusing. As the story proceeded it was apparent what was happening. It was just at the beginning that we were in trouble.

For a couple of hours we discussed what we could do. Many suggestions were put forward, and the air grew blue with cigarette smoke. In the end we decided to cut out completely a couple of short flashbacks, and to add a background noise to the first two. Accordingly out came the Fi-Cord and we went into the kitchen. George rolled up his sleeves and washed up the beer glasses, and I set the recorder going. We then superimposed Roddy's mother's conversation with the boy Roddy on to this background, and substituted these two new sections for the sections already on the master tape.

Although the result is an improvement, I still feel that, at the beginning of the play, something more is needed to indicate the flashback. Anyway, we settled for what we had done and, after cutting out and inserting the pauses we had previously noted, we dubbed the master tape on to a clean tape, carefully adjusting the volume from the notes we had made.

It was just two months from the initial setting of pen to paper to the finished production. It was all great fun—and tremendously worth while!

REDUCING WOW AND FLUTTER

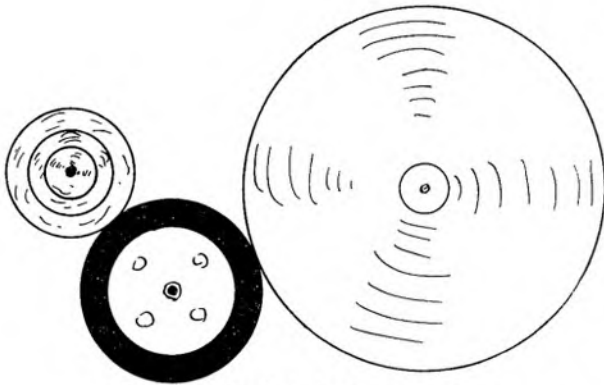

Fig. 1(a). Typical three-speed lay-out

EVEN expensive tape recorders are not always completely free from the slight variation in tape speed which causes wow and flutter; in such cases it is best to have the fault investigated by the manufacturers. **Tampering with high quality or semi-professional machines is not advisable.** But where cheap recorders are concerned, you may feel that there is little to lose and usually a good deal to gain from some judicious attention to the mechanism.

The decks of popular recorders, being mass produced, naturally vary in performance, as the low price precludes anything in the way of "hand-made" construction; it needs considerable time and patience to reduce component parts from approximate dimensions to the fine limits necessary for high-class results. This extra polish can be successfully produced in the home workshop by anyone who has the necessary patience and mechanical skill. It cannot be too strongly emphasised, however, that it is a slow process which cannot be hurried; the greatest care must be taken.

The whole object of hand finishing is to try and correct errors which may only amount to thousandths of an inch, so it will be appreciated that the methods used cannot be too drastic, as replacements for damaged parts may be hard to obtain. If the deck is comparatively new, make sure that it has had sufficient use to be thoroughly "run in" before deciding that it needs attention.

When speed variation has definitely been proved, the first step is to check that the trouble is not due to something simple, such as dirty heads or tape guides, or slipping belts. Give the deck a good clean before doing anything else. Belts and associated pulleys should be wiped with a clean dry cloth, but the glazed surface which develops on neoprene capstans and pressure rollers is best removed by holding a slightly damp

cloth against the revolving surface. Felt pressure pads also pick up dirt and develop a "skin" which can set up flutter.

When everything has been thoroughly cleaned, check for stiffness in moving parts. A rubbing spring (or a dry bearing) is enough to cause trouble; the slightest trace of petroleum jelly on a pulley spindle often makes all the difference, but *keep oil and grease well away from all rubber surfaces and from tape guides.*

The tension of pressure pads and pressure rollers may be checked by gently pressing and pulling on these parts during playback, and listening to the result. Too much pad pressure could mean that the pads, acting as brakes, were really controlling tape speed, rather than the capstan.

On the other hand, a weak pressure roller spring (or stiff pressure arm bearing) could allow slip at the capstan, in which case the varying pull of the take-up motor would be the governing factor. Slip could also be caused if the surface of the pressure roller was not parallel with that of the capstan.

"Rough" tape guide

It might be found that a tape guide had worn "rough" or was pinching the tape, in which case a few light strokes from a small fine file should effect a cure. Possibly the guides might only be loose or out of alignment, causing the tape to rub on the tape reel; a bent reel could also produce speed variation. A point which might be overlooked is the head mounting screws, which can on occasion work loose, although this does not often happen as the screw heads are usually sealed.

If everything seems in order so far, check that the brakes are working properly and not rubbing when they should be clear of the drums. Normally, brakes are completely off when the deck is in operation, except in those decks which use a light brake on the left-hand reel to provide tape tension in the R/P position. Three-motor decks make use of opposing motor torque to obtain the necessary tension.

Should the trouble still persist after checking the above points, it must be due to some, possibly slight, eccentricity in

the chain of pulleys between the capstan and its motor.

A very severe test, even for professional recorders, is to record a pure tone, such as the B.B.C. tuning note, and to play this back; any wow or flutter will be mercilessly exposed and it is often possible to find one pulley which revolves in step with the error. Even if the cause can be discovered in this way, it is a good idea to "touch up" other likely sources of error when the deck is dismantled.

Fig. 1a shows a typical layout for providing three speeds. The three-step pulley is usually mounted on the motor spindle, and the drive conveyed to the capstan flywheel by means of a rubber-tyred intermediate wheel which can be moved in or out of contact. This wheel can also move in line with its axis, in order to select the appropriate pulley step. The speed is governed by the relationship between the motor pulley step and the flywheel, and the intermediate wheel is not part of the gearing, but merely takes the place of a belt.

Eccentricity in any one of these parts will produce a variation in tape speed. Fig. 1b shows, very much exaggerated, an example of eccentricity and the method of removing the "bump" by gradually bringing a suitable tool into contact with the revolving part so that the "bump" is levelled and the part made as truly round as possible.

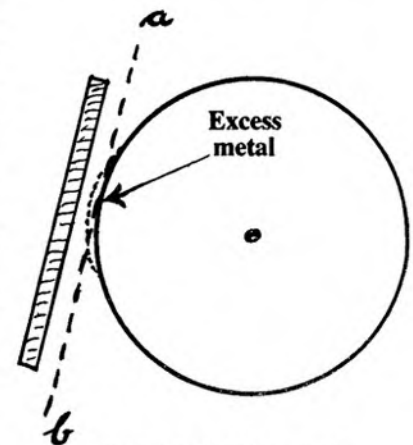

Fig. 1(b). Grinding tool

An ingenious method for improving the performance of inexpensive recorders described by L. REID

In this operation as little metal as possible must be removed or the recorder may not run at standard speeds. It is unlikely that there will be any danger of this; but even if it did happen, the slight alteration in pitch would, in my opinion, be preferable to wow or flutter. In any case, very few of the cheaper recorders are dead "in tune," so the point is of academic interest only. When eccentricity is excessive, owing, say, to an off-centre pulley boss, the only remedy is a new part.

The home workshop is usually only equipped to deal with very small errors; often little more than a "wire edge" caused by something knocking against the part after it was machined.

Simple Equipment

So little metal is to be removed in these operations that very simple equipment will suffice. Several carborundum oilstones of various grades, and some smooth cut flat files (fairly new ones are best, as they need less pressure) will serve to correct the larger wheels. For three-step and small pulleys use the miniature oilstones known as "slips" in fine and medium grades; while for rubber, the best tool is a piece of flour-grade glasspaper glued to a flat strip of wood. There must be no creases in the paper, so it must be firmly stuck to the wood.

If you are skilled in lathe work, metal-working tools will give quicker results on really large wheels such as flywheels, but do not attempt to use such tools unless

you are familiar with their use. Fortunately, flywheels and capstans are usually made to close limits and normally need no attention; errors are more likely to be found in the motor pulley and rubber wheel, both of which respond much more quickly to attention.

To check progress, use can be made of a handy little micrometer device known as a Test Indicator (Fig. 2) which is simple to use and comparatively inexpensive; the pointer indicates thousandth of an inch. For use in restricted space it was found helpful to extend the operating button of the gauge; a suggested extension is shown. NEVER hold any sort of gauge against a part revolving under power; the part must always be turned slowly by hand.

There are three essentials to be observed in all grinding operations:—

1. Both the part being ground, and the grinding tool, must be held very firmly, to prevent chatter. It is well worth while to knock up a few simple jigs to suit your deck and any parts removed from it for attention; these will always be useful for future adjustments. Fig. 3 shows one method of holding the deck (a slight tilt may be needed where flywheels have only one bearing). Fig. 4a shows a mounting board to which the capstan motor may be attached; if the board is made to the same dimensions as the deck it can replace the latter on the deck jig.

The diagrams also show how the grinding tool is held firmly on a hinged "tool holder." Fine adjustment is pro-

vided by a piece of $\frac{1}{8}$ in. dowelling, which is pivoted eccentrically between the two vertical guides. To prevent chatter, the hinge used must have no free play.

2. The second essential is to grind everything on its own bearings. The flywheel, when this does need attention, will, therefore, usually have to remain on the deck, but most other wheels and pulleys can be removed complete with their bearings for attention. The motor pulley is dealt with by attaching the motor to the mounting board as at Fig. 4b, and the rubber-tyred wheel is also attached to this board in such a position that it will be driven by the motor pulley.

3. Metal dust must not be allowed to reach bearings or drop into other parts of the recorder. Polythene sheet and a tube to the vacuum cleaner can be a help in this connection. If parts being ground are mounted as shown, with the axis in a horizontal position and the tool operating on the lower edge, dust will fall clear of the bearings.

(Continued on page 28)

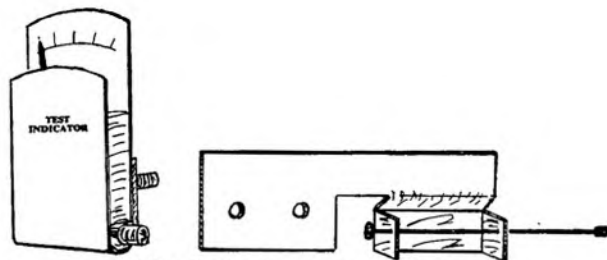

Fig. 2. Simple micrometer device

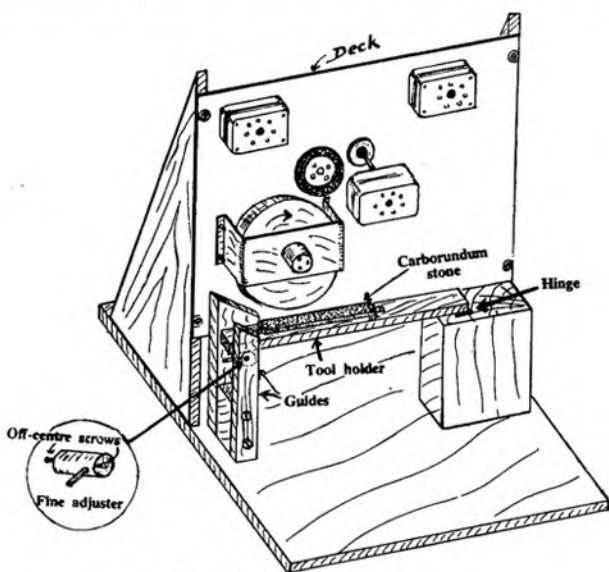

Fig. 3. Jig to hold deck

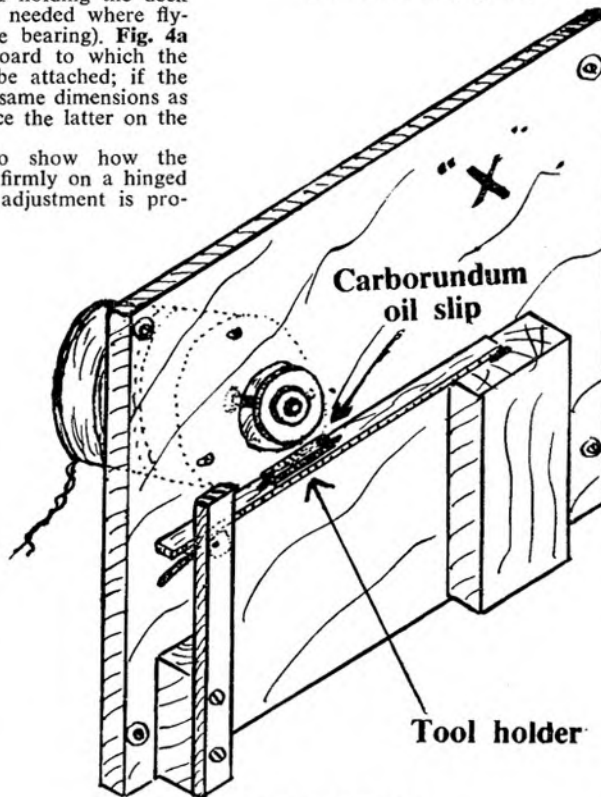

Fig. 4(a). Jig for motor

Sound Effects

ALAN EDWARD BEEBY, who has had long experience in devising and recording sound effects, continues his regular column of advice.

If there is an effect you want, and which is causing difficulty, write to him for guidance.

SOUND effects, like many other forms of recorded material, fall into numerous categories, and when a reasonably wide selection has been acquired, either by the lone enthusiast or tape recording club, it becomes evident that, in order to make the best possible use of the items at his disposal, the effects-man must place his collection in some sort of systemised order.

The "master" copies of these items will, naturally, exist in tape form. I have been asked many times: "Is tape the best medium for storing sound effects?" In other words: tape . . . or disc?

Well, I'm going to place my head firmly and squarely on the chopping-block and say, "Disc." This is, mind you, a purely personal "thing" of mine; to me, there's something rather more permanent about discs than tapes . . . at least, where sound effects are concerned!

Discs, I know, can easily get broken. This, however, is really a double-bladed argument, since tapes are no less accident-prone in their journeys across the business end of an inactive (?) erase-head!

Another point in favour of sound effects on disc is that many enthusiasts working alone are not always able to secure a second recorder for dubbing purposes, while almost all recorder-owners possess disc-playing equipment of some kind or other.

The first thing to do when starting to build up a sound effects library is to make a list of all the more general items which may be needed, and to separate these into categories, such as: weather, street-noises, crowd-noises, sea-effects, railway-sounds, and so on.

You will find, in one or two cases, that the categories are apt to overlap. Crowd-noises, for instance, would be equally at home in either the street-noises list or the railway-sounds section. This may appear rather obvious in explanation, but it is all too easy to throw the whole catalogue out of gear before you've even started by not being strict enough with listing arrangements.

Each effect, by its own nature, will demand a precise place in the appropriate list in your catalogue. This

simple rule can be the means of ensuring a good deal of space-saving in your library and, incidentally, a fair amount of hard cash, if and when it comes to having the effects transferred from tape to disc. Bad grouping can often mean paying for the same thing twice.

Secondly comes the problem of labelling the individual effects. Let's take the railway-sounds, as an example. You probably won't need reminding that there is more than one type of locomotive (ask the Editor, he's an expert on this subject!)

The "Flying Scotsman" has a totally different sound to that of a slow-moving heavy goods train pulling, rather grudgingly, out of a siding at Bletchley! This is where quite a large number of amateur recording enthusiasts slip up, by fondly imagining that: ". . . so long as it's a train-noise, it's bound to be all right for the job."

The same thing applies, of course, to all branches of sound effects. Do make sure that your effects are portrayed, and labelled, as accurately as possible.

The various railway-train "actions" must also be featured individually. Passing through, arriving and stopping, moving off, and the sound heard from within the train when travelling (called "train-rhythm") are just four that will come readily to mind. This last item lends itself admirably to the employment of the continuous tape loop.

The street-noises list will consist of road-traffic effects only. This is where the overlap occurs, which I mentioned earlier. Pedestrian-traffic effects can be discounted, as these will be included in the crowd-noises list and can easily be mixed-in with the road or rail-traffic sounds when needed.

Road-traffic effects might consist of car, van, lorry, bus, motor-cycle and horse-and-cart noises, each one being featured in the four main "actions," as for the railway-train list.

The listing of crowd-effects needs little explanation. The accompanying illustration will show how my own items in this section are drawn up: Each "track" (they're all on disc) has its own number, and by reading the

CROWD EFFECTS			
ACTION	ONE	FEW	MANY
WALKING	P/1	P/2	P/3
RUNNING	P/4	P/5	P/6
TALKING	-	P/7	P/8
SHOUTING	-	P/9	P/10
JEERING	-	P/11	P/12
CHEERING	-	P/13	P/14
BOOING	-	P/15	P/16
CLAPPING	-	P/17	P/18
EFFECTS	P/1-4	DISC NO.	ED/27
"	P/5-8	" "	ED/28
"	P/9-12	" "	ED/29
"	P/13-18	" "	ED/30
DISC/78	rpm/r	O/G	4/8/54

headings horizontally and vertically, the required effect can be easily and quickly found. This method of listing can be applied to almost any effects-group, provided, as I said before, that care is taken to assign each effect to its correct class.

Weather-effects come in three parts: rain, thunder and wind. Each of these is further divided into individual "actions": thunder-clap (single), thunder-roll (continuous) and thunder-rumble (distant). Drizzle-rain, steady, downpour and sleet. Slow moaning wind, fierce howling wind, and wind-gusts (steady pitch). Variations are possible on almost all these weather-effects, by altering the speed at either the playback or recording stage.

Sea-effects overlap, partly, into the weather category, since, in popular imagination, the two are practically synonymous. It is, however, only necessary to include *water* effects in your sea-scape list, as any actual weather items can, again, be taken from that particular group. Among the water-noises may be mentioned: wave-effects (heavy and medium), water-lapping, sea-wash on sea-shore (gentle) and sea-wash with breakers (heavy).

By the way, don't forget to include

(Continued on page 28)

Equipment Under Test

THE TRIX “EVEREST”

By E. A. RULE



THE Trixette Tape Recorder costs 49 guineas and is supplied complete with a crystal microphone for hand or table use, a 7-inch reel of tape and spare tape spool. It is fitted with the Collaro Studio tape deck, which has three four-pole induction motors and push-button controls. There are five buttons: play, fast wind, fast rewind, brake and pause. It is also fitted with a digital counter.

Two inputs are fitted to the recorder amplifier, each with its own gain control; by using the two controls either input can be recorded by itself, or they can be faded one to the other, or they can be mixed, i.e. background music with a commentary at the same time.

One input is for microphone and requires four millivolts to fully modulate the tape; the other is for either gramophone or radio, and needs 400 millivolts. Both are high impedance and utilise jack sockets.

In addition to the mixing facility, there is a superimposition switch, which removes the voltage from the erase head and enables a new recording to be made over an old one—the level of the old recording is reduced to half volume during the process.

While a recording is being made it may be monitored on the internal loudspeaker by adjusting the control marked “play/monitor” until the required volume is obtained. Care must be taken if a microphone is in use, or feedback between loudspeaker and microphone may result.

Just above the push button marked “play” on the tape deck there is a small lever which must be pulled forward and depressed with the play button before a recording can be made. This is an effective safeguard against accident erasure for the lever controls a switch that disconnects the heads.

By setting the record/playback switch on the amplifier to “record” but not depressing the play button on the tape deck, it is possible to set the levels of the various inputs on the magic eye indicator without setting the tape in motion. The amplifier can also be used as a gramophone amplifier by feeding a pick-up into the gram/radio jack socket and monitoring on the internal speaker.

The Trixette Everest was tested for frequency response and the resulting curves are shown opposite. A measurement of hum and noise was made and found to be -40dB relative to two watts output (this was measured as the ratio of a fully modulated tape to unmodulated tape using a 1,000 cps sine wave recorded 6dB below tape saturation level). The figure of 40dB is less than the claimed figure of -50dB , but could be improved by a slight adjustment of the hum-bucking coil, which is mounted just below the record/replay head. It is possible that the hum-bucking coil had moved during transit, its setting was very critical and it needs to be adjusted carefully for optimum results.

A test of the bias waveform showed a very good sinewave and was also very stable in frequency, which on the recorder tested was 46kc/s .

Erase is clean and recordings clean from amplifier noise, except at maximum volume when some hum was present; this was found to be hum from the mains transformer induced into the replay head. This was not noticeable at normal replay volume. However, there is a tone control which is switched out during recording, of the top cut type and with ample range of control.

(Continued on page 24)

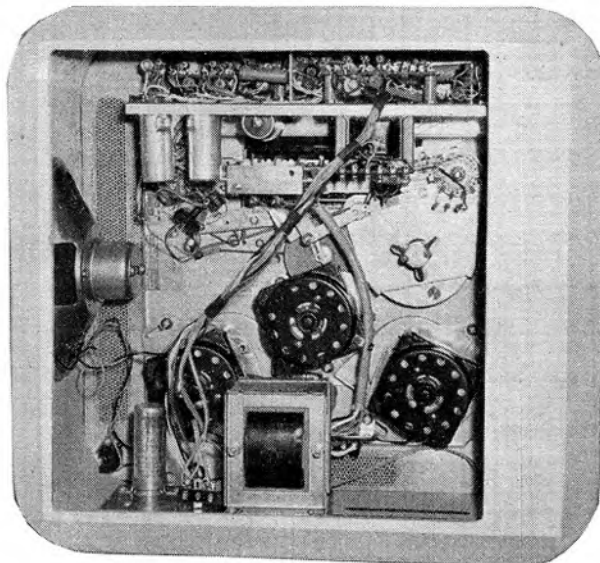

The Trix recorder's power supply sub-chassis is at the bottom of our photograph, left. Note the generous size of the mains transformer. On the left of the cabinet is the high flux speaker and just to the right of this can be seen the hum-bucking coil. Above this is the main amplifier chassis with the output transformer just below, and the tape deck fly-wheel to its right

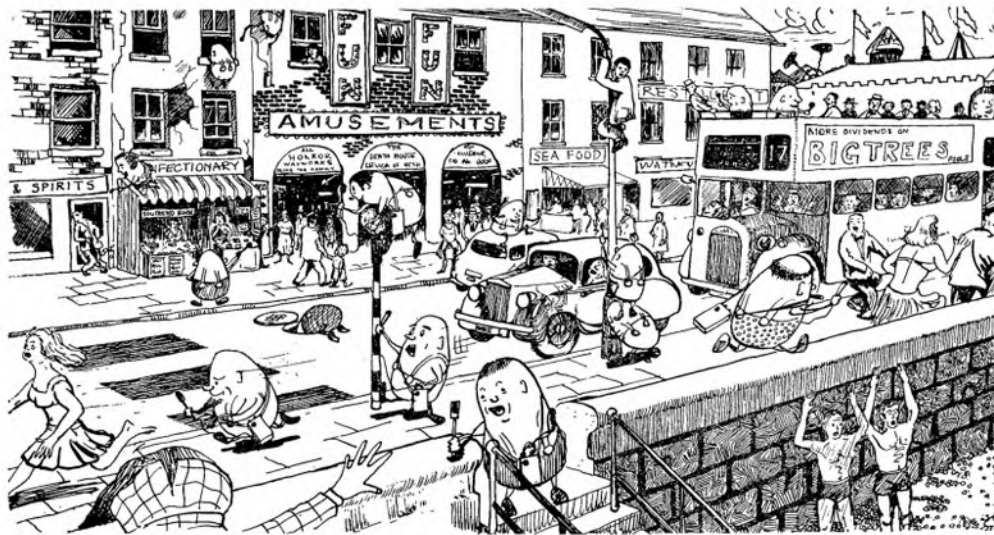

Trix Everest

(Continued from page 23)

A jack socket is fitted to the back of the tape recorder and a 3-ohms extension loudspeaker may be connected to this if required. The internal loudspeaker is disconnected when this socket is in use. Using a G.E.C. metal cone loudspeaker with a Wharfedale Super 3, in a hi-fi speaker cabinet, re-playing some recordings made from a VHF tuner gave very pleasing results; the bass response was clean and the treble crisp. Some slight hum from the H.T. supply was noticeable on this system.

The recorder is fitted with a high flux elliptical 7 x 4 in. loudspeaker, which gives very good reproduction, due to the large baffle area provided by the tape recorder cabinet.

The amplifier is very soundly constructed; all components are fitted either to group boards or tag strips. The standard of soldering is very good

Manufacturer's note: We are modifying the equalising circuits which will give an improved high frequency response.

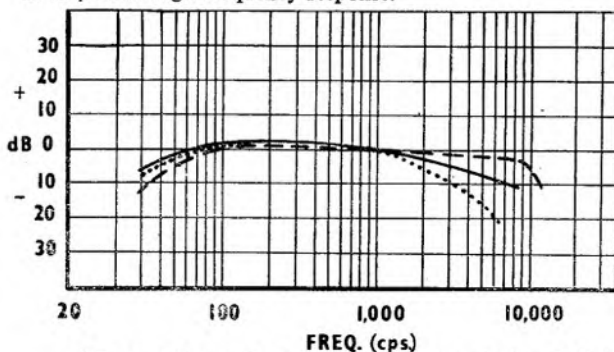

"Everest" recorder frequency response tests. Ref. 0dB=1,000 cps

and no "dry" joints were found. It is fitted with a very large mains transformer and after over two hours playing there was no sign of overheating anywhere in the recorder. The mains transformer and two contact cooled rectifiers are mounted on a small sub-chassis, which is firmly fixed to the back of the cabinet.

Recordings made from a VHF tuner were crisp and clean, without any sign of wow or flutter. Using the crystal microphone supplied, recordings were lacking in treble but otherwise gave good reproduction. At low volume levels some noise from the tape deck motors could be heard coming from the cabinet, but it was almost inaudible with the cabinet lid closed. The amplifier controls worked smoothly and without any noise.

The Everest Tape Recorder deserves credit for its very soundly engineered construction and elegant looks; it is simple to operate and the mixing facilities should appeal to the more advanced recording enthusiast.

Terry Devereux illustrates, above, the lighter side of club life! The cartoon purports to show members of The London Tape Recording Club on a day's recording outing to Southend-on-Sea. Obviously under the influence of our regular artist Jeeves, members have disguised themselves as "Soggies" for the occasion!

MEMBERSHIP of a tape recording club offers the enthusiast full opportunity to make the best use both of his machine, and of his own inherent (and, perhaps, hitherto unsuspected) capabilities. A tape recorder is a machine of social facilitation, revolutionising the means of communication between people of different localities. The full potentialities of the tape recorder are not yet realised; the clubs, in their own way, can claim to be "pioneers."

Within comparatively few years, public libraries may issue tapes as well as books. The student may be able to listen to the author's voice, as well as to read his words. There are already "listening libraries" in the United States of America; in this country, various organisations have tapes available on loan.

The tape recorder offers many ways in which we can give, and gain, knowledge and understanding of the world about us. A tape club is very much more than the sum of its individual members, for a democratically-planned programme, en-

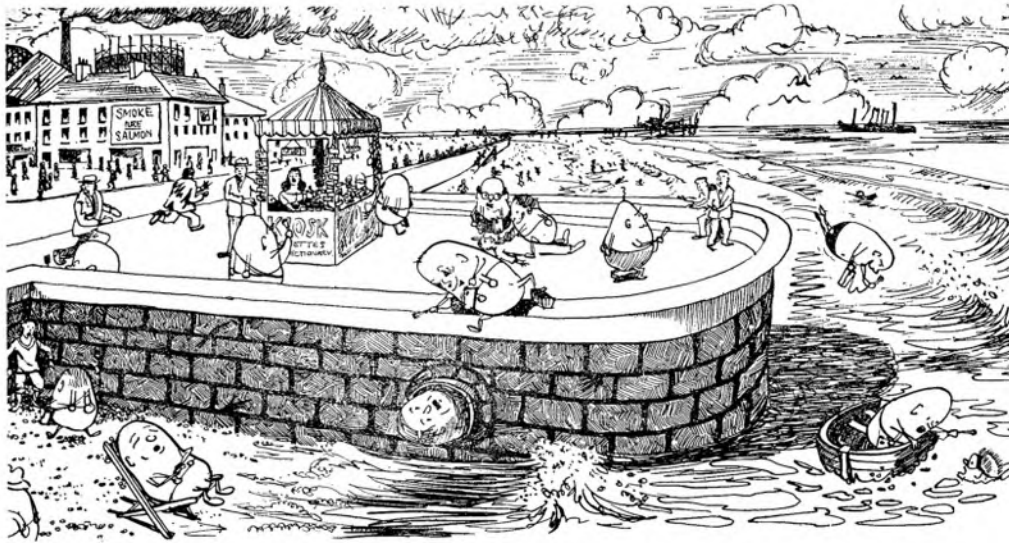

... and, in more serious mood, DAVID DOVE writes about

OPPORTUNITIES FOR CLUBS

joying the support of all members, can make a real impact on the life of the community.

A tape club can have a great deal of fun, and make a real contribution to the local scene, in capturing the neighbourhood "on tape." Every member of the club can be delegated to record interviews and to collect information for inclusion in a tape on a particular topic of local interest—"The History of Our Town" or "Our Town Fifty Years Ago," for instance.

Every member would be made responsible for collecting information of some kind; to avoid duplication, each member would be given a particular part of the project. One would try and record an interview with one of the town's older inhabitants, another would attempt to trace the history of the local "Co-operative" society, one would meet the Town Clerk, another the retired station-master.

Such a club project would require planning and patience, but it would have the advantage of utilising the energies of members, and of creating something of lasting interest. There is, in fact, a great deal of useful "research" that awaits the enthusiastic tape recording club; in local organisations of all kinds, from youth clubs to old folks' associations, there lie many experiences, many tales worthy of inclusion in a "tape for posterity."

A copy of your completed tape project should be presented to the local council or to the public library, in order that it can be made available to interested persons. Of course, if it is especially successful, you may persuade the authorities to include it in any future rocket despatched to Mars!

Members of the club can also be delegated to ascertain "public opinion" on

various contemporary topics. Here again, the nature of the question asked would be determined by the club and, indeed, the wording of the question also, in order that individual recorded interviews would be related to each other. If a fairly controversial topic were selected, members would have to agree to the exact wording of the question to be asked of willing acquaintances.

For instance, the same person might give a different answer to the question "Why don't you agree with Sunday cinemas?" than if he were asked "Do you think that people should please themselves what they do on Sundays?"

Perhaps every member, presuming that all owned, or could borrow, a recorder, would be asked to record one or two interviews, each with a time limit (4 or 5 minutes). Subjects could include "How to find happiness," "Modern Youth," or even—in the best *Readers' Digest* tradition—"The Most Unforgettable Person I have ever met." Members will have many other suggestions for topics. From individual submissions, a final tape would be compiled for the club library (two copies at least, just in case one is accidentally erased).

One Birmingham enthusiast has expressed an ambition to record local dialects before the cosmopolitan life of modern Britain destroys them for ever. Here is a fine opportunity for inter-club co-operation.

Tape clubs can also work with other local bodies, including dramatic and choral societies and discussion groups. Some of the latter use recorded tapes to introduce the topic under discussion. If the club is really energetic, it can express its willingness to record wedding receptions, christenings and the like.

Exchanging tapes with other clubs,

especially those abroad, is already part of the programme. This can be improved by the addition of a few well-chosen, visual aids. For instance, if your club recorded a tape on "Life in Our Town" for a club overseas, the inclusion of some postcards, showing scenes mentioned in the tape, or some photographs or drawings, will give your tape that extra life. People usually like to look at something, even when listening quite intently. (Just watch your guests with those glossy LP record covers next time they come to hear some Beethoven!)

A club can also find a great deal of scope in working with old people's associations. There are many old people who would very much like to attend a service in their own church, but who are unable, through infirmity, to do so. The recording of a service and the playback to these old people brings much joy to those who might otherwise have been forgotten. The sick, too, are speeded towards recovery when they hear a tape of friends wishing them well. In all, the tape club can be an important part of the social life in your town.

It is a very good idea to have a voluntary and imaginative public relations officer, and to publicise the activities of the club wherever possible. As far as activities themselves are concerned, they should be of interest to novice and semi-professional alike, especially as the popularity of tape recording means that there are more of the former than the latter. Instruction on machine maintenance—and simple explanation of technical specifications—should be offered to the "youthful amateur."

Many clubs issue their own journal—usually duplicated—and this serves as a means of informing members of activities.

(Continued on page 28)

Large speakers—if possible Small speakers—acceptable “Middle” speakers——?

JUDGING from what I heard at the Radio Show the man-in-the-street now has a much better idea of the nature and purpose of stereo. In fact the commonest type of argument I heard consisted of a difference of opinion over the value of what stereo offered rather than over what it was all about.

There is very little one can do about this more personal matter. It is easy enough to give the main facts about how stereo works, but it is impossible to satisfy the craving some people seem to have for facts and figures to prove that stereo is more enjoyable than mono.

Three times at the Show I heard this comment, or its equivalent: “Yes, but I don’t want to hear exactly where every instrument is situated. It doesn’t interest me.”

How can we make such excessively sales-resistant types understand that separation is a means to an end—music that is more immediate and exciting—and not an end in itself?

However, there are not many people left who are really against stereo. Most of those who listened to a few of the excellent demonstrations at the Show were already convinced or came away convinced of its worth.

Some of the Audio Hall demonstrations were rather too long for the average show tourist, but they were generally down to earth. There was a lot of good reproduction of music and much of it came from moderately proportioned speaker cabinets.

For anyone concerned with getting stereo into normal homes the loss of the very lowest frequencies may have to be accepted as inevitable in the interests of reasonable cabinet size.

A very good exercise for would-be stereo owners is to listen long and carefully to comparable speaker assemblies with frequency responses going down to 30 cps and 35 cps respectively, switching instantly from one to the other from time to time if possible. It is useful to have a true feeling for just how little (or how much) is lost by using the smaller assembly.

People like Goodmans and The Gramophone Company were doing a good job at the Show with medium-sized speaker assemblies. The latter’s new stereo pick-up gave an excellent account of itself in conjunction with the brilliant 556 “Stereoscope” pre-amplifier and 557 10+10 watt stereo amplifier and two compact speakers using elliptical drive units.

The G.E.C. demonstration with three Slender Periphonic speakers gave food for thought. Hugh Brittain and his colleagues stress that such a system is only for the purist, and I think it would not produce more than a fractional improvement over the results obtained with two of these splendid speakers in an average room at home.

However, if we are thinking in terms of a small concert hall, or an installation in a ship or library, then the advantage of the third speaker is really appreciable—and there is certainly a growing tendency nowadays to give stereo concerts.

The middle speaker, carefully fed with a proportion of each signal, not only helps to avoid left-right exaggeration, which can occur with rather widely-spaced speakers, but also keeps the line of sound straight instead of concave. Most stereo reproduction involves a suggestion that the instruments in the centre are a little further back “on the stage.”

I am uneasy on one score only. The third speaker is a luxury for purists while stereo recordings are made with good reproduction systems in mind, but if there should be an increase in the tendency of the recording companies to exaggerate the left-right effect for the benefit of cheap reproducers which can only register crude separation, then we might find ourselves compelled to fight back with the third speaker to regain true stereo. Hugh Brittain told me that his experiments were partly due to the fact that there are so many “tink-tonk” recordings about.

Once again the truth shines forth—there is no room for compromise in the world of stereo. Manufacturers of equipment, the recording engineers and the lovers of reproduced music must keep their sights on the centre of the target. Wavering at any point sets in motion a train of confusion that, if allowed to continue, leads to the disappearance of stereo in thin air.

Stereo has arrived. Let us now simply make sure that it stays.

Reflectograph : new unit

BELIEVED TO BE the first British professional quality equipment specially designed for making copies of tapes, the Reflectograph D costs £57 15s.

Deliveries are to begin during November.

The Model D comprises the Multimusic tape deck and a specially designed playback pre-amplifier. It can also be used for the playing back of tapes when connected to a high-quality amplifier. Facilities for rack mounting are provided.

Multimusic Ltd., Maylands Avenue, Hemel Hempstead, Herts.

* * *

Magazine E.A.R.

A RECENT addition to the E.A.R. range is the G375 recorder which incorporates the Garrard Magazine deck and costs 25 gns.

It has a single speed of 3½ ips and the frequency response is quoted as 60-9,000 cps for 6 dB down. Power output is rated at 2.5 watts. Measuring 8½ x 15 x 6¼ in., the recorder weighs approximately 20 lb.

Facilities include a bass/treble control, superimposition, mixing of high and low impedance signals, and mixing of the playback signal and a signal injected at the high level socket. The machine can also be used as a straight amplifier.

Electric Audio Reproducers Ltd., The Square, Isleworth, Middlesex.

* * *

Long-life tape

A NEW recording tape, developed in America, has the magnetic oxide coating covered with a thin plastic. It was produced for use with data processing machines, which often call for very heavy use, but is suitable for use with domestic recorders.

The plastic covering avoids rubbing off oxide and the consequent loss of recorded data. It is claimed to prolong the life of the tape ten times.

* * *

Stolen

THE following Wyndors Victor recorders were stolen recently from Messrs. Sheen Tape Recorder Centre Ltd., 8, Station Parade, Sheen Lane, London, S.W.14; serial numbers 21722 and 21724.

A Grundig TK 35 serial number 502761840 was also stolen from the Rex Cinema, Norbury, London, S.W.16, along with an Ecko VHF radio serial number 58065. A reward of £20 is offered for information leading to the recovery of this equipment.

"SOUND" INTRODUCE New Products PROFESSIONAL MODELS

FOLLOWING close on the heels of the new four-track versions of the Sound Prince and Sound Studio recorders, is the announcement of two further models in the range of Tape Recorders (Electronics) Ltd.

The new models are the Sound Master and the Sound Connoisseur.

The first is a three-speed, $7\frac{1}{2}$, $3\frac{3}{4}$ and $1\frac{1}{2}$ ips, four-track professional standard tape recorder equipped with an acoustically designed bass reflex loudspeaker system.

The record/playback frequency response is quoted as 30-18,000 cps ± 3 dB, and the amplifier only response as 20-20,000 cps ± 3 dB. Signal-to-noise ratio is given as within 70 dB, and the combined wow and flutter as better than .14 per cent.

A full range of facilities include superimposition, mixing, pause control, digital rev. counter, safety erase lock, meter recording level indicator, separate bass and treble controls, two extension speaker sockets, an extension amplifier socket, and the ability to record simultaneously from the playback output.

Inputs are provided for microphone, radio/pick-up.

Undistorted output is rated at 10 watts, with a peak output of 14 watts. A third, built-in 7 x 4 in. elliptical speaker provides monitoring facilities.

Maximum spool size is 7 in., making possible a total of 18 hours playing time on double-play tape.

The weight of the Sound Master is 42 lb., the size of the recorder $18\frac{1}{2} \times 15\frac{1}{2} \times 11$ inches, and the speaker cabinet, $20\frac{1}{2} \times 18\frac{1}{2} \times 29\frac{1}{2}$ inches, and included in the price of 85 gns. is a dynamic microphone, spool of tape, spare spool, and recording leads.

The second model also has three speeds, $7\frac{1}{2}$, $3\frac{3}{4}$ and $1\frac{1}{2}$ ips, and is available in two versions. The two-track model complete with high-gain crystal microphone, 7 in. spool of tape, spare spool, and recording leads retails at 65 gns., and the four-track de-luxe version with the same accessories, is priced 70 gns.

The facilities are identical to the Sound Master with the exception of the ability to record from playback. Straight-through amplifier facilities are provided. A magic eye recording level indicator is employed.

Quoted frequency response is 50-16,000 cps ± 3 dB at the top speed, and amplifier-only response is given as 20-20,000 cps ± 3 dB. Signal-to-noise is quoted as -55 dB, and wow and flutter as better than .14 per cent.

Loudspeakers employed are two 10 x 6 in., one 8 x 5 in., and one 3 in. tweeter. Output is rated as $4\frac{1}{2}$ watts.

The dimensions of the Connoisseur are $30 \times 15\frac{1}{2} \times 10$ in., and as can be seen from our illustration, the sepele mahogany cabinet is mounted on 19 in. detachable legs. The weight is 34 lb.

Untarnishable gilt edging is used



throughout the model, and both models are suitable for the tropics.

An added feature of the Connoisseur is the storage space provided at the rear of the deck. This is ample for recording leads, microphone, tapes, etc., and will accommodate a tuner if desired.

Both models incorporate a built-in loudspeaker muting switch, operated by fully inserting the jack plugs.

Tape Recorders (Electronics) Ltd.,
784-788 High Road, Tottenham, London,
N.17.

GRUNDIG ADDITIONS

A POCKET guide for service men, which at the same time answers many of the day-to-day problems encountered by dealers has been published by Grundig (Great Britain) Limited.

Written by H. P. Spring, A.M. Brit. I.R.E., M.I.P.R.E., Grundig's chief engineer, the book describes in simple terms the basic design, specifications and servicing of Grundig tape recorders. Many aspects which can affect the performance of the machine, but are not generally appreciated are also explained.

Also by Grundig, is a plastic three-pronged tape cleaning attachment, illustrated below, now supplied with the TK 24. Two of the three prongs, designed to fit into holes in the deck of the recorder, are fitted with felt round which the tape travels to remove dust and other foreign particles.

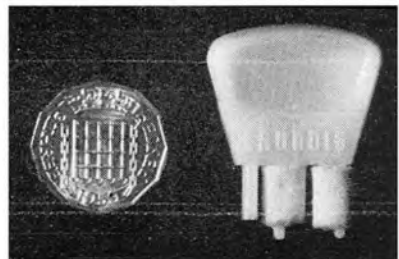

Accessories for Elizabethan

TO GIVE facilities for stereo on their new FT1 and FT3 four-track models, Elizabethan are offering an attachment which allows stereo playback and mutiple recording on the FT1, and both these factors, plus stereo recording, on the FT3.

The attachment speaker and amplifier

unit, in two sections, is exactly similar in appearance to the two tone grey FT1 case. The cost is 19 gns.

A new high gain crystal microphone is available with the FT1 and FT3, and the separate cost of this is 2 gns.

Elizabethan (Tape Recorders) Ltd.,
Romford, Essex.



Reducing wow and flutter

(Continued from page 21)

The deck motors will usually provide sufficient power for grinding operations provided the tools and stones used are free cutting.

Start by checking the flywheel. Mount the test indicator *firmly* on some part of the deck (a small block of wood can often be utilised) so that the button bears lightly against the flywheel rim, and turn the wheel slowly *by hand*; any variation will cause the needle to move across one or two divisions on the scale.

As these represent thousandths, it is essential to hold the gauge firmly to obtain a correct reading. Failing a gauge, run the deck at its highest speed and advance the empty tool holder to touch the flywheel rim, when any eccentricity will be heard at each revolution.

In the unlikely event of an error showing, proceed to grind off the "bump" by attaching a coarse carborundum stone or flat file to the tool holder and cautiously bringing the tool into contact. If a stone is used, it must be worked dry, as oil would reach the rubber wheel which is providing the drive; the stone should be frequently cleaned with a rag just damped with paraffin. Fig. 1b shows how the tool should gradually be advanced, and when the position of the dotted line "a-b" is reached the rim should be true.

Listen for the sound of the "bump" hitting the tool, and when this noise

becomes less intrusive, as the metal wears off, advance the tool slightly and continue. Theoretically it should be possible to eliminate all irregularities, when there would be a continuous rubbing sound.

Apart from listening in this way, switch off frequently and check with the indicator, if you want the most accurate results.

If you are unlucky and the flywheel needs grinding, this will be the most tedious part of the work. Assuming that this part has been passed, attention should next be given to the motor pulley, but first take careful note of the deck layout before dismantling anything. Sketches and labels are a great help here, if there is any doubt.

The grinding is carried out in a similar way to that of the flywheel, but the parts are attached to the mounting board. This has a hole large enough to allow the motor pulley to pass through; other holes are drilled to suit the motor fixing bolts and grinding is done with a fine or medium oil slip. In this case oil can be used. Make sure that all pulley edges are ground at right angles, and not rounded.

By attaching a suitably shaped block to the board in position "X" it is possible to pivot the arm of the intermediate wheel so that the latter bears on the motor pulley and is driven by it; a light spring holds it in contact, but the two wheels must be *held firmly* together during grinding.

When dealing with rubber tyres, extra care is necessary as the surface is very liable to tear or roughen; remove all rubber "crumbs" as they form on application of the fine glasspaper. Although the diameter of the intermediate wheel does not affect the speed, this should not

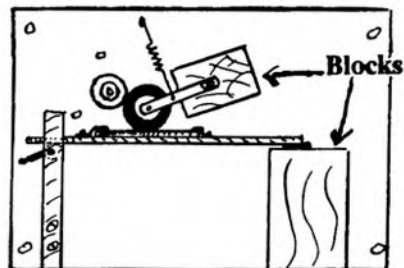

Fig. 4(b). Mounting rubber wheel

be reduced drastically or there may not be sufficient pressure to prevent slip. As a final check, the capstan can be tested with the indicator.

Reassemble the deck and make another recording of the pure tone; compare the playback of this with the first one, made before working on the deck, and note how successful your efforts have been.

Although these operations sound rather complicated, they are really quite simple and only need care and patience to carry out.

Sound effects

(Continued from page 22)

a recording of the good old stand-by seagull's cries in your sea-scape list. Have them recorded by themselves, though, and not to an accompaniment of water-effects. Remember, seagulls fly inland as well as over the sea. You can always put sea-noise in if necessary, but you can't remove it once both sounds are on the tape or disc together!

Other useful items in the sea-effects list are: a rowing-boat effect, motor-boat engines, anchor-chains, creaking timbers, rope-pulleys, ships' bells, sirens, hooters, and the steady throb of a ship's engine.

There's a great deal to be said for careful listing and storing of sound effects, as any professional effects-librarian will tell you. Being an amateur makes no difference, the aim is the same: to have *any* sound effect immediately to hand whenever the need arises. And, you know, it makes things a whole lot easier if you know just where to look for it!

When writing to manufacturers for information about new products, please mention that you saw it in "Tape Recording Fortnightly Magazine."

Opportunities for Clubs

(Continued from page 25)

ties, as well as providing them with a platform for their own views and ideas. Journals can be a good recruiting medium, too. A potential member may be prompted to join by the appearance of your publication.

It is worth remembering that "electronic stencils" costing about 15s. will reproduce any drawings, charts or photographs on your duplicator, if it is in a full-size and fairly modern machine. Such a stencil can be kept for future use, and can be used to good effect for the cover of the journal, if you can find an artist to draw some suitable design! An electronic stencil is foolscap size, and you could make your journal very pictorial by including drawings in the text on three or four pages. One stencil could be used for all these; you would have to cut the stencil up and insert the pieces containing the drawings in your ordinary wax stencil.

Even if your duplicated journal is straightforward without any embellishments or illustrations, it can be made attractive by careful and imaginative layout. Needless to say, printing is the best method of reproduction, but this is usually beyond the budget of tape clubs. One word of advice: do not issue your publication too frequently. It is better

to keep your members impatient for the next issue than to issue a different one every fortnight or so. The usual period between issues seems to be about a month.

Reports of meetings in your local papers should be short, but interesting, accounts of your activities. Indicate, if possible, how interested readers could join. It is advisable that your club keeps in touch with others, certainly through the pages of *Tape Recording Fortnightly Magazine*, and, to some extent, by inter-club activities.

Your club can also build up a "pool" of equipment owned on a co-operative basis. There are many useful items which may be somewhat expensive for individual use but which a club might well hold—tape erasers, outdoor equipment, mixers, microphones, etc.

Finally—the golden rule—give your members something to do. The happiest, and most loyal, member of your club is the young person who thinks that his contribution to its life is of value. A club project, in which all can participate, will keep your members busy.

Some people say that the art of self-expression is passing. With the advent of the tape recorder it may enjoy a new renaissance.

Letters to the Editor

Have you an idea, a complaint, or a bouquet to hand out? Write to us about it. Letters not for publication should be clearly marked

Which numbering for 4-track?

Now that four-track recorders are coming on to the market in ever-increasing numbers, I feel that it is essential to make sure that standards are set up and adhered to, before we find ourselves in a similar stupid situation to that which arose when two-track recording began to become standard practice.

As many will remember, the continental machines recorded on the opposite track to that of the British and American machines. Consequently, it was impossible to exchange tapes made by the two systems. Eventually, of course, things came to a head, and it was settled by making the British/American method the international standard.

Now, on four-track, we do, at least, start with a standardised type of recording head. This has two sections, vertically stacked, one playing the upper outer quarter track, the other the lower inner quarter track. But the question now has arisen as to which track is called what and also in which order should they be recorded?

The majority of recorders number their tracks quite logically 1, 2, 3, 4, counting from top to bottom of the tape. This means that tracks 1 and 3 are recorded in one direction and tracks 4 and 2 in the reverse direction.

But Grundig have, apparently, decided to be different, as they call their tracks 1, 4, 3, 2. Consequently, tracks 2 and 4 are in different positions on the tape to the normal sequence, whilst 1 and 3 remain as they were.

To further complicate matters, it is suggested by some manufacturers that tapes be recorded in the sequence 1, 4, 3, 2 (which to Grundig becomes 1, 2, 3, 4) rather than in what would appear to be the logical order 1, 2, 3, 4.

The reason for this is based on a fallacy, as they state, that by doing it this way only one movement of the track switch is necessary. In fact, this is not so.

To record in sequence 1, 4, 3, 2 the track switch must first be in position 1/4 to record tracks 1 and 4, then switched to position 2/3 for the next two tracks, 3 and 2, but it *must* be switched back to 1/4 in order to make the next recording. This can very easily be forgotten, causing accidental erasure of track 3. So two switching operations are necessary, not one.

To record in sequence 1, 2, 3, 4 the switch must be in position 1/4 for track 1, switched to position 2/3 for tracks 2 and 3 and then back to 1/4 for track 4. This leaves the track switch automatically in the correct position for the next tape, so that there is little likelihood of recording on the wrong track. This takes only two movements, exactly the same as the other method, but is far

less confusing and leaves no doubt as to which track you are recording or playing.

Personally, I find the 1, 2, 3, 4 sequence not only much easier to remember, as well as being more logical, but far less likely to lead to error. I correspond with a number of friends in other countries, some of whom also possess four-track recorders like mine. Naturally, we have discussed this matter fairly thoroughly, and I would be interested to see comments by other four-track owners in the pages of *Tape Recording Fortnightly*.

Some of my friends prefer the 1, 4, 3, 2 sequence simply because it is recommended by the manufacturers, but several agree with me that 1, 2, 3, 4 is better and should be preferred as a standard. It is very noticeable that the ones who use 1, 4, 3, 2 are quite often confused as to which track they are recording, whereas the 1, 2, 3, 4 adherents never have any trouble this way.

Despite the rather discouraging remarks made recently in your pages when you reported the meeting held by Stuzzi, I find that four-track (as far as the average home recordist is concerned) is quite as good, and often better quality than many of the existing two-track recorders give us. Its signal-to-noise ratio may be a little low to the super hi-fi fan, but I doubt whether the average person would hear any noticeable difference between a good four-track and a good two-track recording. Only instruments would be able to detect the difference under the normal home recording and playback conditions.

I've never experienced difficulties such as were quoted, like drop-outs on the tape, and I have used all kinds of tape with no obvious difference between the four-track and two-track reproduction either on outer or inner tracks. I also find that tracks 1 and 4 line up perfectly well with more than 95 per cent of my tapespondents, both two- and four-track, and I feel that reports about four-track

and the difficulties likely to arise are rather exaggerated when it comes to putting the system to practical use.

On the question of playing stereo tapes, many four-track recorders are advertised as needing only an extra amplifier (and speaker, of course) to play full stereo. With the majority, this is not really so, as it is no good using a radio set, for example, as the right-hand channel, unless you also use a pre-amplifier.

For those who, however, are lucky enough to possess another recorder, like myself, the problem is simplified. In most cases, the second channel can be fed directly into the mike input of the second recorder, which is set for P.A. operation. The left-hand channel then is reproduced by the four-track machine through its own amplifier, and the right-hand channel by the second recorder, the mike volume control being used to set the volume for the right-hand channel.

Balance is obtained by varying the two separate volume controls, one on each recorder, but is quite easy to obtain, particularly if you use a test tape.

Ideally, of course, both amplifiers and speakers should be identical, but, as long as they are not too different, the results are surprisingly good, and well worth listening to. It is also worth the effort to make a set of stereo headphones. These give you quite a startling stereo effect, somewhat different from the more normal two-speaker set-up, particularly with certain recordings.

An old ex-government pair of headphones re-wired so that each receiver is connected separately to the appropriate channel (and properly phased) makes quite a good—and very cheap—stereo headset.

I would like to see one or two more articles in future issues discussing four-track recording, its advantages, and its future, and possibly some experiments in stereo using the four-track system.

DONALD JEATER.

Weymouth, Dorset.

The Rest is Silence?

I WAS much amused to read in Mr. Beeby's article that "the sound of a person's head being chopped off by the executioner's axe . . . can be achieved by plunging a table knife through a large carrot."

Not having heard the sound of a man's head being chopped off I will not argue. What does Mr. Beeby suggest would imitate the noise of a person's

neck being broken as he falls through the trap and comes to the end of the executioner's rope? And what about a nice juicy squelch as the villain finally perishes under a steam-roller?

Seriously, though, isn't this sort of thing a bit too much in tape recording?

J. R. WILLIAMS.

Shipley, Yorks.

A NEWS ROUND-UP



Equipped with his Grundig Cub, Al Burnette (right) of that smart night-club, the Pigalle, greeted Marty Allen and Steve Rossi (seated) when these two top American cabaret stars flew in to London Airport recently. With them in our photograph is delectable Ann Austin, also of the Pigalle, who fell in love with Steve's voice. Now they've met, it looks set fair for a fine romance. Marty and Steve will be keeping the customers happy at the Pigalle during the next few weeks.

MAGAZINE DIGEST

In this column we draw attention to items published elsewhere which may be of particular interest to readers.

The Tape Recorder (September): *A custom-built stereo recorder.* Describing the construction of a unique design machine.

Tape Recording (American) (July): *A remote control is nice!* T. Thomas describes the advantages of a remote control unit on a microphone.

Amateur Tape Recording (September): *Tape recorder maintenance.* Simple precautions to ensure efficient working.

A NEW method of adding sound effects and music to previously recorded dialogue on video-tape has been perfected in Los Angeles by station KTLA, one of the leaders in tele-recording technique.

Special equipment was developed by Ampex, employing a 2 in. multi-track audio tape, similar to video-tape, which can accept as many as eight subsequent recordings.

Its use after initial production means that tape has now the same facilities as film for dubbing and thus "heightens the dramatic intensity of the programme."

★ ★ ★

Eric Daniel, has been appointed head of a research unit of Ampex Electronics at Reading. He will work under Dr. Peter Axon.

★ ★ ★

International Colour-Vision Ltd., is a firm set up in Britain to hire out a system of colour vision taping developed by Philips in Holland.

Hi-Fi **HARRY** by rich



Photographic blow-ups of the old "Penny Plain—Twopence Coloured" juvenile drama sheets, beloved by the children of the Victorian era, are being used by Grundig (Great Britain) Ltd., for the latest window display at their New Oxford Street showrooms.

The display was designed and executed by Peter Norwood, and the photographic reproductions were taken from the original plates now the property of Pollocks Toy Theatre Limited.

"TAPE RECORDERS ONLY"

ALL POPULAR MAKES, CASH OR TERMS

Specialists in GRUNDIG and Service and Guarantee implemented without return to the manufacturers

TAPES Service Spares

DIXON'S ELECTRONICS

227 OXFORD ROAD, MANCHESTER 13

(Telephone: ARDwick 4269)

Bib RECORDING TAPE SPLICER

FOR EASIER AND ECONOMICAL TAPE EDITING

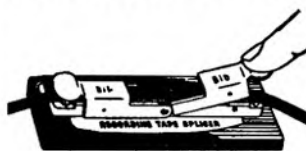

The easy-to-lift clamps on the new Mark II Bib Recording Tape Splicer are both hinged on the same side of the splicer, making the jointed tapes easy to remove. Precise, rapid tape jointing is ensured, and because you can use all the odd lengths of tape, you soon save the cost of the splicer.

Everyone who uses a tape recorder will need this little tool. It is indispensable. P. Wilson. "The Gramophone." Send a stamped addressed envelope for a helpful leaflet on tape editing.

18/6 each (subject)

If you have difficulty obtaining a Bib splicer, let us know the name and address of your dealer.

Multicore Solders Ltd., Multicore Works, Hemel Hempstead, Herts. Tel: Boxmoor 3636

News from the Clubs

Edited by
FRED CHANDLER

CLUBS are normally formed with the express intention of making the most of the particular medium with which the enthusiasts are concerned. Photographic, cycling, and our own tape recording clubs have all been formed following the natural desire for the keen exponent of the art to further his capabilities.

Each of the ninety-odd clubs, now formed for the tape enthusiast, was inaugurated when the members concerned found that shared experiences and techniques would improve their know-how. The availability of the extra recorder or recorders provided another incentive taking into consideration the extended scope for editing, dubbing, mixing, etc.—a must for the keen tape man.

There are also clubs which are formed where tape only serves as a means to another end. We have heard of the national and international tape correspondence clubs, the Tape Organ Club (where members are primarily interested in organ music and use tape as a means of expanding their knowledge and experience of this form of music), and the dramatic groups, where tape is playing an increasing part within the realms of self-criticism.

Now I hear of another club, which has progressed to tape for communication purposes and to bring closer to the members the principals around which the club revolves.

Alan Williams of Liverpool, is the guiding light in this new idea, and he is helped by Brian Field of Brighton. These two gentlemen are the branch leaders in the respective areas for the fan club of the popular singing group *The Mudlarks*.

Although only in its initial stages, the idea is that at regular intervals a tape will be posted to all members of the special tape section of the fan club, giving details of the latest news of *The Mudlarks*, and including interviews with other popular singing groups and individuals.

An interview with *The Avons* was a highlight of the first tape produced, now in the process of despatch. Craig Douglas, has already been interviewed by Brian Field, and together with a per-

sonal message from *The Mudlarks*, recorded by Alan Williams, will be included in the next tape now in the editing stage.

The magazine plays for about thirty minutes and is sent to ten members scattered throughout the country. They even have one member in Germany. Details may be obtained from Mr. Field at 13 Gardner Street, Brighton 1, Sussex.

A slight jump in subject, but a huge stride geographically, brings me from broadcasters to broadcasting. From the Australian section of the **World Tape Pals**, Eric Yeomans writes to ask if any of the clubs in the U.K. is interested in providing tape material for the Australian equivalent of the BBC "Sound" programme.

It seems they have quite a job gathering sufficient interesting material to guarantee continuity for their weekly radio programme.

Reading of the items produced by many of the U.K. clubs Mr. Yeomans believes that much of this material would be of international interest. Clubs or individuals interested should contact him at Queens Road, Silvan, Victoria, Australia.

The type of tape Mr. Yeomans would welcome, I am sure, is that produced by the **West Middlesex** members who recently spent a day at Whipsnade Zoo.

Equipped with Butoba, Fi-Cord and a Stuzzi Magnette portable, members split into three groups and proceeded on a course best designed to capture as many impressions of the animals as possible.

But the animals had other ideas. Although they were visited at feeding time, judged to be the most productive session of the day, the majority seemed to have had some warning, and they had prepared their best table manners. Even

the cat family was badly represented, except a desultory growl from a lion.

The seals obliged most handsomely, however, and together with several interviews with the keepers, provided a great deal of material.

The August 24 meeting at Southall was taken up with playing back the tapes collected, and arrangements were made to start the work of editing these into a feature tape at the September 8 meeting.

Also at the meeting, a further tape from Fred Gazeley concerning his scheme for the blind was played, and a recording made of the subsequent discussion.

The meeting felt that Mr. Gazeley could best be helped by individual offers of dubbing, reading, and technical assistance, as such help was liable to be required at short notice. This rather ruled it out as a club activity.

Outside visits also have been a feature of the **Millom** club—with the emphasis on trains.

The club planned a recess for the month of August, but work piled up so quickly that meetings had to be restarted after only two weeks rest.

First of the jobs to be completed was a visit to the Ravenglass and Eskdale narrow gauge railway. Some recordings are already in the club's library, but fuller coverage was thought wise, due to the railway's threatened closure.

Their second train session necessitated a visit to Millom's gas-lit station to record the hooter blast of a diesel. The club blotted its copy book when it was found that the only mains current available was from the Stationmaster's house. They plugged in, and blew his fuses four times.

The resultant gap in the club's effects library is not likely to be filled for some time, although Mr. Mallinson of Portishead came to the rescue with some good train noises recorded on a Clarion portable recorded at Bristol's Temple Meads Station.

Tape exchanges with overseas clubs is gaining momentum. The most recent tapes have been received from Wind-

(Continued on page 33)

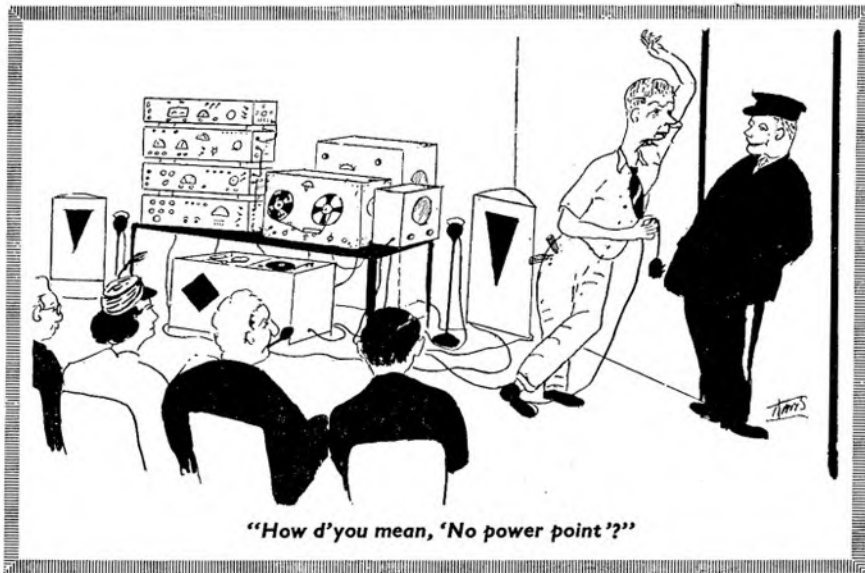

Classified advertisements

Rate—Sixpence per word (minimum 5s.); Trade, ninepence per word (minimum 10s.); box numbers, one shilling extra. Payment with copy. Copy should be sent to Advertisement Department, "Tape Recording Fortnightly," 1, Crane Court, Fleet Street, London, E.C.4.

GRUNDIG sales/service in your area: High Wycombe phone 457, Newbury phone Thatcham 3327, Wallingford phone 3083, Orpington Kent, phone Orpington 23816, New Malden phone Malden 6448, Watford phone Garston 3367.

GRUNDIG TK5, £40. Little used, inclusive mike, carphones and four tapes. Box 388, Tape Recording & Hi-Fi Magazine, 1 Crane Court, Fleet Street, London, E.C.4.

PHILIPS 3538 A 3-speed 7-in. wheel; two tracks. Nearly new, £44 or near offer. H. King, Lobster Cottage, Clay Lane, South Nutfield, Redhill, Surrey.

PRE-RECORDED Tapes (Stereo and Mono) at less than half price. Lists given. Box 387, Tape Recording Fortnightly Magazine, 1 Crane Court, Fleet Street, London, E.C.4.

SWOP new TK20, 4-track to same value? Cash £38. New accessories, electrical goods, swop for LP, DP tapes, 4 Kings Avenue, Alfred Street, Aston, Birmingham 6.

DEVELOPMENT ENGINEER for laboratory of highly reputable tape recorder manufacturers. Electronic and mechanical experience in this specialised field essential. Wyndor Recording Co. Ltd., 2 Bellevue Road, Friern Barnet, London, N.11.

STERN'S Recorder as new, microphone, tape, £25. Cadenza Ribbon Microphone £6. Offers considered. Evenings: Culpeper, 30 Rothesay Avenue, Greenford.

PERFECT Stereo, Mono tapes for sale, consider exchange Ortofon Mono Heads, good V.H.F. Tuner or Stereo Amplifier. Genuine offers only. Box 386, Tape Recording Fortnightly Magazine, 1 Crane Court, Fleet Street, London, E.C.4.

1959 FERROGRAPH 4S recorder. As new, cost £92, sell £70. D. Sheppard, 3 Carey Road, Newport, Mon.

PHILIPS AG8107/00 twin track recorder, mike and 850 ft. tape, all as new, £25 o.n.o. G. Dore, 38 Church Street, Llangollen, Denbighs.

FOR SALE. Grundig TK8, two years old, excellent condition, 35 guineas or near offer. R. J. Langham, 16 Furze Hill Road, Tidworth, Hants.

FOR SALE. Grundig 4-channel mixer as new, £8. Grundig microphone as new, £4 10s. C. Denning, Riverdale, Cowley, Middlesex.

Tape to Disc—All Speeds Rendezvous Records. 19, Blackfriars Street, Manchester 3. Leaflet on request.

WANTED. Simon SP4 Tape Recorder or similar, second-hand, in perfect working order. Alan, 1st Floor, Ritz Cinema, Sheen Road, Richmond, Surrey. Phone Richmond 6464.

FRIENDLY FOLK ASSOCIATION, 87, Terrace, Torquay. Leading International Correspondence Hobby Club since 1943. Now included, facilities for Tapesponding Details free.

Bargain parcel. Splicing Tape with Splicer, Tape Calculator, four different colour marker tapes, twelve hundred feet branded recording tape (new). Money back guarantee. Send £1 10s. now. Watford Supplies, 81, Queen's Road, Watford, London.

JOHN HASSELL RECORDINGS. Tape/Discs. All Speeds. CCIR Studio, 21, Nassau Road, London, S.W.13. Riverside 7150.

Tape recorder need repairing? Then let London's Largest Tape Recorder Specialists do it for you, expertly and economically. Essex Tape Recorder Centre, 2, Maryland Point Station, Stratford, E.15.

Recording Tape. Save up to 30 per cent. Send for list. Also 50 secondhand Recorders in stock. E. C. Kingsley & Co., 132, Tottenham Court Road, London, W.1. EUS 6500.

EASYSPLICE TAPE SPLICER SPECIAL OFFER 3s. 9d. plus 6d. p. & p. guaranteed for easy accurate tape splicing. Easysplice Co., 30 Lawrence Road, Ealing.

FOR SALE. Philips AG8108G Tape Recorder, cost £65, excellent condition. What offers? J. G. Coppenthal, c/o Mrs. Smith, 6 Hatton Lane, Northwich, Cheshire.

FERROGRAPH 4 A/N's-808's, VORTEXION WVA, WVB, SIMON SP4, REFLECTOGRAPH A-B, etc., always in stock and ready for immediate delivery, as well as over 200 latest 1960 recorders at London's Largest Tape Recorder Specialists. The best, lowest H.P. terms, and finest selection of new and s/h recorders, from £18. Generous P/E allowances. Essex Tape Recorder Centres, 2, Maryland Point Station, Stratford, E.15, and 205, High Street North, East Ham, E.6.

E.S.T.R.A. The English Speaking Tape Respondents' Association is a new club founded to promote tape friendship. Membership world-wide. Details from Honorary Secretary, Robert Ellis, Whitsome, By Duns, Berwickshire, Scotland.

Wanted—Good recordings of laughter. Natural, spontaneous, side-splitting and convulsive. Write first to Box 378.

DECCA Stereo, extra loud speakers, cost £75, exchange for Fi-Cord complete with batteries charger and microphone. F. Ankrah, 12 Ellington Street, London, N.7.

MINIFON pocket wire recorder with desk microphone/speaker, throat microphone, mains transformer, spare reel, batteries. As new, no reasonable offer refused. Box 385, Tape Recording Fortnightly Magazine, 1 Crane Court, Fleet Street, London, E.C.4.

GRUNDIG Cub recorder for sale. First class condition, only £15. Write, Christopher Denning, Riverdale, Old Mill Lane, Cowley, Middlesex.

TELEFUNKEN 85-KL complete with mic. Mint condition. £70 (cost £88). P. Stanmore, 12, Pollard's Hill North, London, S.W.16.

BINDERS

The ideal way of preserving your copies of *Tape Recording Fortnightly Magazine*. These new binders are designed especially to hold a year's supply of the fortnightly publication—26 copies.

No more torn covers and dog-eared edges ★ No more hunting for those mislaid copies ★ Each copy is inserted as received to form a completely bound volume for permanent reference ★ All pages open flat and effect secure binding with steel bars from first to last copy ★ Strong board binders covered with rexine with the title printed in gold on spine.

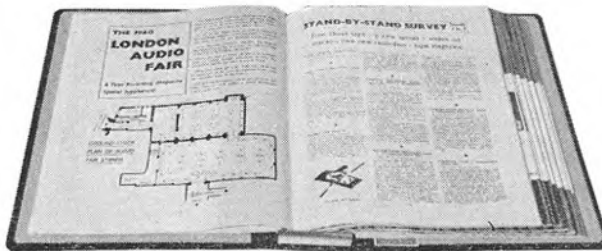

ORDER NOW PRICE 14s. 6d.

From: *Tape Recording Magazine*,
7, Tudor Street, London, E.C.4 (post free)

News from the Clubs

(Continued from page 31)

hoek, and Durban in South Africa, Adelaide, Montreal and Singapore.

News of two new clubs, in Kent, and Yorkshire.

In Kent, Mr. J. E. Periam is already in touch with several enthusiasts and an initial meeting was arranged for early September. No further details yet, but prospective members are invited to write to him at "Treetops," Boxley Road, Penenden Heath, Maidstone.

Mr. G. F. Clegg of 5, Friarage Mount, Northallerton, Yorkshire, is still attempting to form a club, and would like to hear from interested persons.

The Ilford club meetings are in future to begin with an hour devoted to the fundamentals of recording. Electronics Engineer Jeff Langley provided the first of these sessions at the September 13 meeting, and will continue the "course" at subsequent meetings.

Another change which took effect at the meeting concerned a re-shuffle of the committee. Dave Bolton succeeded Secretary Jeff Langley who now holds the post of programme secretary. Bill Gates is the new Treasurer.

The Singapore Naval Tape and Disc Club has now been officially formed. The inaugural meeting was held at the beginning of August and Ron Hellyer was elected secretary. His address is 157b, Cyprus Road, H.M. Naval Base, Singapore.

Tape and disc stereo is a popular feature in the Naval base at Singapore and it is for this reason the disc suffix has been used in the club's title.

The club is very keen to hear from U.K. clubs, and letters or tapes, help

and advice will be most welcome from clubs in this country.

A quiz tape presented by members Mr. Morris and Mr. Palmer was played at the August 25 meeting of the Rugby club, and won by blind member Mr. Jack Willis. Following this, members heard excerpts from a tape of the voice of local boy Keith Shervington singing in the Holy Trinity Church, kindly loaned by his mother.

The remainder of the evening was devoted to the approval of the new set of rules for the society's constitution.

The arrival of the new "bumper" edition of the Directory of Members should keep members of The Voicesspondence Club very busy selecting names of possible contacts.

Over 1,300 names are included in the new list and a remarkable fact is that one in five of the names included are of blind members. The U.K. section are still admirably looked after by Fred Gazeley of Beckenham and proof of his interest and untiring devotion to blind tape enthusiasts can be found elsewhere in these pages where we give details of his activities to provide a tape magazine.

A recording contest among members is now in progress, and among the judges is Kenneth Miller of New York, who produced the tape "Contact Microphone" which won a prize for the most humorous tape in the 1959 International Tape Recording Contest. The prizes in the Voicesspondence contest will include "Golden Microphone Trophies" similar to the "Oscars" awarded to stage and screen stars.

I am asked to point out that Ronald Davies is no longer on the publicity and membership committee of the organisation. Inquiries now should be addressed to Lee Lacy at 15, Fentons Avenue, Plaistow, London, E.13.

Out with a Portable

(Continued from page 17)

driving system goes. If then the strobe-tape is rewound and anchored to the take-up spool a second run will show if it is still constant. If it is that lets out the take-up side.

All the tensions, bearings and other mechanical influences have to be just so if the speed is to be constant and as near to the specified speed as possible.

Batteries: Basically everything depends on the battery supply in the case of midget recorders. It should be a type which can easily be replaced and obtained everywhere. There is much to be said for simple 1.5 volt dry cells, mounted in a cassette. Several types of small accumulator are now available so here is food for thought.

For the enthusiast or professional user, I'd say accumulators, but for the casual user dry cells should serve.

Monitoring: Whilst full monitoring facilities are in the "nice to have" class, I do not feel they are essential. If a loudspeaker is envisaged for judging quality in the field, then up goes the size, weight, and battery consumption. There are exceptions of course. With an earphone and a visual volume indicator on the record side, experience and confidence will be bred as results are checked from time to time on hi-fi equipment at home.

Weight: Even now when so many people have cars, mopeds or other vehicles for transport, the amount of walking, fetching and carrying involved with a midget recorder is considerable. So, for comfort, the lighter the better. Don't forget you will require spare batteries, tapes, microphones, as well as a bite to eat on the mountainside or bird-watching by the sea.

By the time you read this, I expect you will be browsing over the literature picked up at the Radio Show. I hope you will find something to suit your needs. By the way there may be a battery/mains job on show there. There is much to recommend this idea to you but I have no experience of it yet. More of this anon.

Just one last thought: if you buy a midget recorder make sure you get a receipt with serial numbers and description of the machine and ancillaries, such as microphones, just in case you wish to take it abroad at any time. The Customs people here regard recorders as they do cameras and typewriters—just your personal luggage—but proof may be required—so be prepared.

CLUB MEETING DIARY

ACTON: Every Friday at The King's Head, Acton High Street.

BIRMINGHAM: Every Monday at the White Horse Cellars, Constitution Hill.

BLACKPOOL: Every Wednesday at 173, Church Street.

BOURNEMOUTH: Alternate Tuesdays at the Civil Defence Centre, Holdenhurst Road (Next: Oct. 4.)

BRIGHTON: Every Tuesday at Fairlight School, Pevensey Road.

CATFORD: Every Friday at St. Mary's C.E. School, Lewisham, S.E.13.

CHESTERFIELD: Every 3rd Monday at the Yellow Lion Inn, Saltergate, (Sept. 13.)

COVENTRY: Alternate Thursdays at Rotherham's Social Club. (Sept. 29.)

CRAWLEY: 1st and 3rd Mondays in month at Southgate Community Centre.

EDINBURGH: 1st Tuesday and 3rd Sunday at 23, Fettes Row, Edinburgh 3

GRIMSBY: Alternate Tuesdays at the RAFA Club, Abbey Drive West, Abbey Road, (Sept. 27.)

GRANTHAM: Weekly. 1st week in month, Wednesday; 2nd, Monday; 3rd, Thursday; 4th, Friday, at Grantham Technical College, Avenue Road.

HARROW: Alternate Thursdays at St. George's Hall, Pinner View, North Harrow. (Sept. 30.)

HUDDERSFIELD: Fortnightly, alternate Thursdays and Fridays at the Congregational Church Schoolroom, Great Northern Street. (Sept. 30.)

ILFORD: Every Tuesday at the RAFA Rooms Cranbrook Road.

IPSWICH: Fortnightly, alternating Fridays and Saturdays at the Art Gallery Committee Rooms (Sept. 24) and the Kings Arms Hotel, Cornhill (Sept. 30.)

KEIGHLEY: Alternate Wednesdays at the South Street Sunday School Rooms, (Oct. 5.)

KETTERING: Alternate Wednesdays at the Rising Sun, Silver Street. (Sept. 28.)

LEEDS: Every Thursday at the British Legion Club, Albion Street, Leeds 1.

LEICESTER: 2nd and 4th Friday at Bishop Street Reference Library.

LONDON: 2nd Thursday at the Abbey Community Centre, Marsham Street, S.W.1.

LUTON: 2nd and 4th Tuesdays at 17, Dunstable Road.

MANCHESTER: Every Saturday, 6 p.m., at 20, Naylor Street, Hulme, Manchester 15.

MIDDLESBROUGH: Every Tuesday at 130, Newport Road.

NOTTINGHAM: Alternate Thursdays at the Co-operative Educational Centre, Broad Street. (Sept. 29.)

RUGBY: Alternate Thursdays at the Red Lion, Sheep Street. (Sept. 22.)

STAFFORD: Alternate Tuesdays at The Grapes, Bridge Street. (Sept. 27.)

STOKE NEWINGTON: Every Wednesday at 53, Londesborough Road, N.16.

WALTHAMSTOW: Alternate Fridays at 26, Church Hill, E.17. (Sept. 21.)

WARWICK: Alternate Wednesdays in Room 18 of the Royal Leamington Spa Town Hall. (Oct. 5.)

WEST MIDDLESEX: 2nd Thursday at the Railway Hotel, Station Road, Hampton, and 4th Thursday at St. George's Hall, Lancaster Road, Southall Broadway.

WEST WALES: 1st and 3rd Thursdays at The Meeting House, New Street, Aberystwyth.

WEYMOUTH: Alternate Wednesdays at the Waverley Hotel, Abbotsbury Road. (Oct. 5.)

WINDSOR: Every Thursday at the Royal Adelaide Hotel.

WINCHESTER: Every Friday at The Ship Inn.

YORK: Every Thursday at 25, Broadway Grove, York.

Unless otherwise stated, meetings start between 7 and 8 p.m.

Is your club included in this list? If not, send details on a postcard, including date of next meeting. The list will appear in future as space permits.



YOUR LOCAL DEALER

In this feature you can check your nearest dealer who is a hi-fi specialist giving expert attention to tape equipment.

LONDON

SHEEN

TAPE RECORDER CENTRE LTD.

Specialists in Tape Recorders and accessories serving London and Home Counties

—THE CENTRE FOR—

FRIENDLY HELP — SALES — SERVICE
HOME DEMONSTRATIONS, DAY OR
EVENING TO SHOW ANY MODEL
YOU REQUIRE — ADVICE ON ALL
MAKES FROM 19 GNS.

CALL—WRITE—PHONE

8 Station Parade, Sheen Lane, Sheen,
London S.W.14. (next to Mortlake Station, S.R.)
Showrooms: PROSPECT 0985 10 a.m.—7 p.m.

CABINETS, ENCLOSURES & EQUIPMENT

GP77. For TAPE or GRAM. 3ft wide, 15 x 15 1/2 deck, 15 x 15 in. control panel. 1ygan Grille for elliptical speaker. In Mahogany, Walnut and Oak Veneer.

PRICE £14.14s.

or £3 deposit and 9 payments of 28s. monthly.

Write for lists or visit showroom.



A. L. STAMFORD LTD., Dept. A.5
84, 86, 98 WEYMOUTH TERRACE
(Off Hackney Road), LONDON, E.2

MIDLANDS

COVENTRY

SPECIALISTS IN HIGH FIDELITY and all makes of Tape Recorders

★ All leading makes of High Fidelity Equipment and Tape Recorders stocked and demonstrated under ideal conditions.

★ The Best Selection and After Sales Service in the MIDLANDS.

R-E-S (COVENTRY) LTD.
128 FAR GOSFORD STREET

Phone: Coventry 28781/2

THE SOUTH

There is always something extra when you buy a TAPE RECORDER from

THE HIGH-FIDELITY CENTRE

TAPE RECORDERS — HI-FI SPECIALISTS — RECORDS

LARGEST STOCKISTS

Recorder Hire Service

SEND FOR OUR BARGAIN LISTS OF NEW AND SECONDHAND EQUIPMENT

EQUIPMENT BUILT TO ORDER. Dorking 4229
61 WEST STREET, DORKING, SURREY

PORTSMOUTH and SOUTHAMPTON

Tape Recorder Specialists

APPROVED AGENTS FOR:-

PHILIPS - GRUNDIG - FERROGRAPH
WALTERS ETC.

- ALL MAKES OF TAPE RECORDERS SUPPLIED
- ACCESSORIES AND HI-FI EQUIPMENT
- PART EXCHANGES AND SECOND-HAND MACHINES
- PROMPT AND SKILLED SERVICING

RECORDING MACHINES LTD.

299 Commercial Road, Portsmouth
Telephone: 23097

4 New Road, Southampton
Telephone: 27092

INDEX TO ADVERTISERS

	page
A. L. Stamford	34
Deroy Sound Service	34
Dickinsons of Pall Mall Ltd.	6
Dixon's Electronics	30
Francis of Streatham	6
Gramdeck	2
High Fidelity Centre	34
Howard Tape Recorders	7
Lustraphone Ltd.	4
Magnagraph	34
Minnesota Mining and Manu- facturing Co. Ltd.	14 & 15
Multicore Solders Ltd.	30
Nusound Recording	16
Psycho-Tape Institute	4
Rapid Recording Service	34
R-E-S (Coventry) Ltd.	34
Recording Machines Ltd.	34
Sheen Tape Recorder Centre Ltd. ...	34
Sunderland Sound Services	34
Tape Recorder Centre Ltd. ... Front cover	
The Gramophone Co.	3
Truvox Ltd.	36
Walters Instruments Ltd.	5
Wyndors Recording Co. Ltd.	8

TAPE TO DISC SERVICES

SSS Private gramophone record made from your own tape

Microgroove LPs from 20/6
Standard 78s from 10/6
Mobile Unit available for Weddings, Receptions
Choirs, Meetings, etc. S.A.E. for full details:—
John Leviss, Sunderland Sound Services,
28, Viewforth Terrace, Sunderland S7032
■ If you can hear it—We can record it! ■

TAPE RECORDER HIRE

TAPE TO DISC 78-LP
RECORDING STUDIO
SALES—EXCHANGES

MAGNEGRAPH

1, Hanway Place, London, W.1.
s.a.e. for leaflet or
telephone: LAN 2156

When writing to manufacturers for information about new products, please mention that you "saw it in Tape Recording Fortnightly Magazine"

TAPE TO DISC RECORDING

Microgroove LP from 27/6d.
78 rpm from 11/-

Also 45 rpm

48 HOUR SERVICE

S.A.E. for comprehensive leaflet to:—
Marsh, "Deroy" Sound Service, Little
Place, Moss Delph Lane, Aughton, Orms-
kirk, Lancashire. Tel.: AUG 3102

RAPID Recording Service

78's and L.P's from your own tapes.
Master Discs and Pressings.
Recording Studio
equipped with Bechstein Grand.
Practising studios
with or without accompanist.
Mobile Recording Van.
"Off the Air" Service.

21, Bishops Close, Walthamstow, E.17. COP 3889

NOW ON SALE

**The fullest, most authoritative and
most up-to-date survey of stereo**

THE SUMMER 1960 ISSUE OF

Stereo **Sound and
music** **magazine**

CONTENTS INCLUDE

The Stereo Disc—The Invention and its Development

The Clarinet in Stereo

Saving Space with a Speaker System

Stereophony and the B.B.C.

New Stereo Products

A Distinguished Critic Discusses Rachmaninov Stereo Issues

Microphone Methods for Stereo

Classical, Jazz, Light Orchestral, and Theatrical
Record Review

GET YOUR COPY NOW—BEFORE IT SELLS OUT

2s. 6d.

*If in any difficulty order direct from the publishers,
Print and Press Services Ltd., 7 Tudor Street, London, E.C.4*

THEY **LOOK** SO GOOD

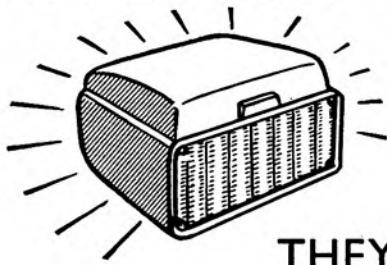

The moment you see the styling of a Truvox Tape Recorder, you know it is the machine for you. Foolproof and simple in operation with professional facilities, a Truvox Recorder will be the centre of your home enjoyment of speech and music. See them at your dealers.

THEY **SOUND** SO GOOD

You'll enjoy "listening" more than ever before. All the technical know-how of a decade of specialisation, to give perfect sound enjoyment, is embodied in the Truvox R6 and R7 . . . the original sound *truly* recorded and *truly* re-played through *large* loudspeakers. Hear them at your dealers.

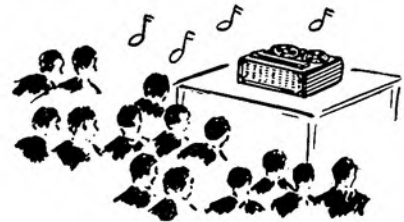

THEY **ARE** SO GOOD

That you'll never be satisfied with any other Recorder . . . once you've seen and heard them, you'll decide for yourself . . .



THEY **MUST** BE

TRUVOX

R.7

H.P. Facilities available.

**SERVICE
IN YOUR
OWN HOME**

R.6

7" spools. 10 watts output.
Records/Replays both directions.
Twin speakers.
Response 30-17,000 c/s.

Retail Price 75 gns.

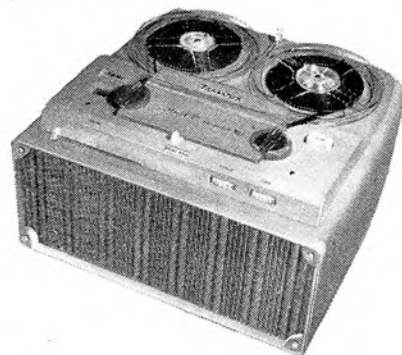

7" spools. 4 watts output.
2 speeds. 8" x 6" speaker.
Response 30-15,000 c/s

Retail Price 55 gns.



Ask your local dealer for a demonstration or full details from:

TRUVOX LTD. NEASDEN LANE, LONDON, N.W. 10 (Gladstone 6455)